



Cambridge IGCSE™

CANDIDATE
NAME

CENTRE
NUMBER

--	--	--	--	--	--

CANDIDATE
NUMBER

--	--	--	--



CO-ORDINATED SCIENCES

0654/33

Paper 3 Theory (Core)

October/November 2022

2 hours

You must answer on the question paper.

No additional materials are needed.

INSTRUCTIONS

- Answer **all** questions.
- Use a black or dark blue pen. You may use an HB pencil for any diagrams or graphs.
- Write your name, centre number and candidate number in the boxes at the top of the page.
- Write your answer to each question in the space provided.
- Do **not** use an erasable pen or correction fluid.
- Do **not** write on any bar codes.
- You may use a calculator.
- You should show all your working and use appropriate units.

INFORMATION

- The total mark for this paper is 120.
- The number of marks for each question or part question is shown in brackets [].
- The Periodic Table is printed in the question paper.

This document has **28** pages. Any blank pages are indicated.

2

- 1 (a) A student investigates the germination of pea seeds.

The student places pea seeds in test-tubes with different conditions and records whether the seeds germinate.

Table 1.1 shows the conditions for each test-tube.

Table 1.1

test-tube	water present?	oxygen present?
A	yes	yes
B	yes	no
C	no	no
D	no	yes

- (i) Predict in which test-tube the pea seeds will germinate.

..... [1]

- (ii) State **one** other requirement for germination that is **not** tested in Table 1.1.

..... [1]

- (b) After the seeds germinate, the plant photosynthesises.

- (i) Complete the sentence to define photosynthesis.

Photosynthesis is the process by which plants manufacture

..... from raw materials using energy

from [2]

- (ii) State the **two** raw materials needed for photosynthesis.

1

2 [2]

- (c) Peas contain protein.

State the name of the smaller molecules from which protein is made.

..... [1]

[Total: 7]

- 2 (a) Petroleum is a fossil fuel.

State the name of **one** other fossil fuel.

..... [1]

- (b) Petroleum is separated into useful fractions by fractional distillation.

State why fractional distillation is a physical change and not a chemical change.

.....

..... [1]

- (c) The fractions obtained from petroleum have different uses.

On Fig. 2.1, draw **one** line from each fraction to its use.

One line has been drawn for you.

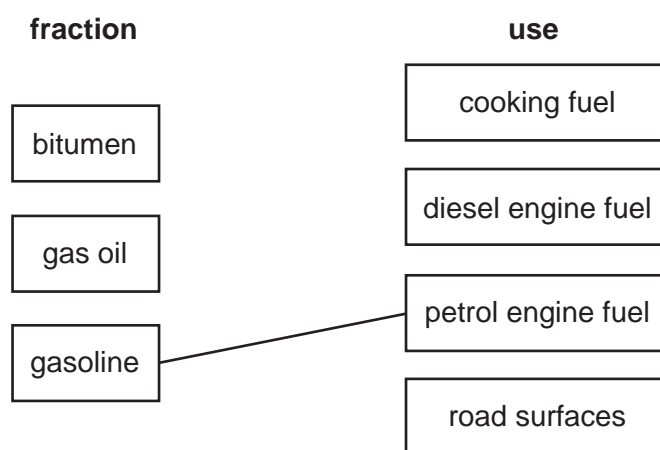

Fig. 2.1

[2]

- (d) Ethane and ethene are both found in petroleum.
Ethane, C_2H_6 , is an alkane. Ethene, C_2H_4 is an alkene.

- (i) Explain why ethene is described as being unsaturated.

.....

..... [1]

4

- (ii) State the chemical test used to distinguish between an alkane and an alkene.

Describe the observation for an alkane and for an alkene.

test

observation for alkane

.....

.....

observation for alkene

.....

.....

[3]

- (iii) State the total number of atoms in one molecule of ethene, C_2H_4 .

..... [1]

- (iv) Complete Fig. 2.2 to show the structural formula of ethane, C_2H_6 .



Fig. 2.2

[2]

- (v) Ethene molecules react together when heated to make a polymer.

State the name of the polymer made from ethene.

..... [1]

[Total: 12]

- 3 (a) Fig. 3.1 shows four forces acting on a submarine. The submarine is moving underwater at a constant speed.

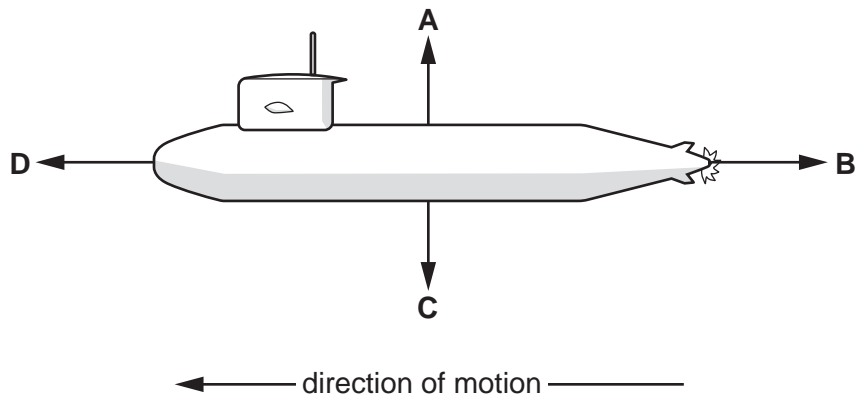

Fig. 3.1

State which force **A**, **B**, **C** or **D** is the weight of the submarine.

..... [1]

- (b) The submarine travels 36 km in 2 hours.

Calculate the speed of the submarine in m/s.

speed = m/s [3]

- (c) The submarine is powered by a small nuclear reactor.
 Ionising radiation is released in the reactor.
 The reactor must be shielded to protect the crew from this radiation.

- (i) State how exposure to ionising radiation can affect the human body.

.....
 [1]

- (ii) Suggest a material which can be used to shield a nuclear reactor and stop α -radiation and β -radiation escaping.

..... [1]

- (d) Plutonium-239 (Pu-239) is the nuclear fuel used by the submarine. Pu-239 has a half life of 24 000 years. A small sample of Pu-239 has a mass of 1.0g.

Calculate the mass of Pu-239 remaining after 96 000 years.

mass = g [2]

- (e) When it is under the water, the submarine uses a periscope to view a ship on the surface of the sea.

Fig. 3.2 shows a simple periscope.

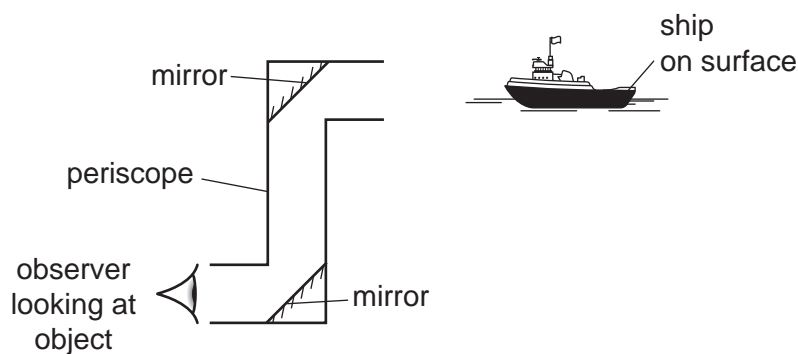

Fig. 3.2

On Fig. 3.2, draw a ray of light from the ship to the observer's eye to show what happens to the light ray as it passes through the periscope. [2]

[Total: 10]

- 4 (a) Scientists investigate diffusion by measuring the distance travelled by two different dyes X and Y.

They place the dyes on agar plates and measure the distance travelled every 15 seconds.

Fig. 4.1 shows the results plotted on a graph.

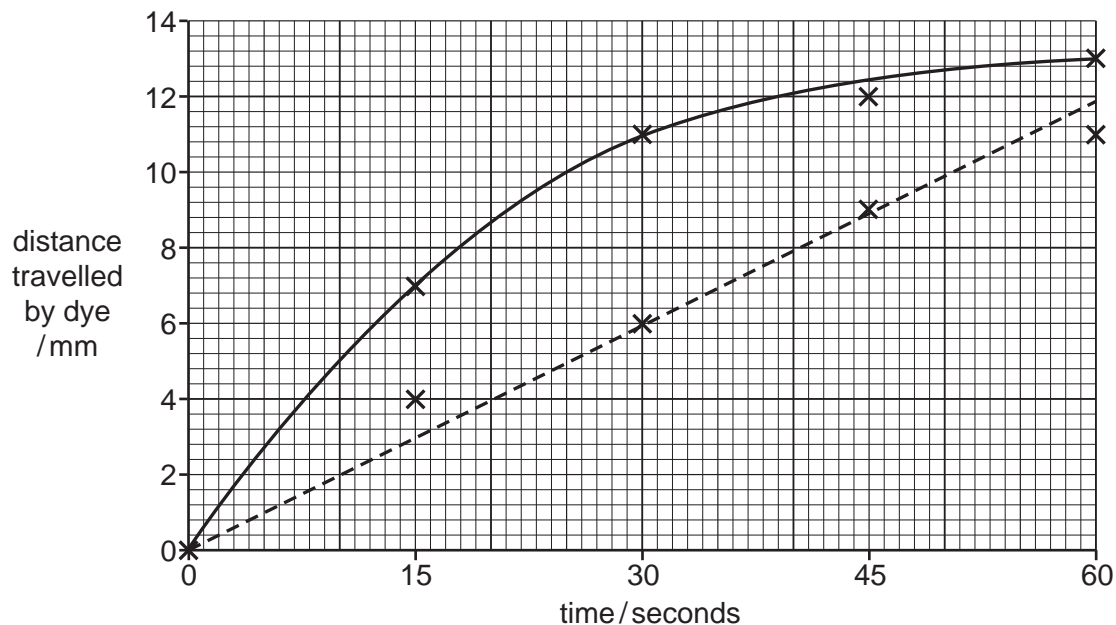

Key

X potassium manganate(VII) —x—

Y methyl orange --x--

Fig. 4.1

- (i) Describe the general trend shown by **both** dyes in Fig. 4.1.

.....

 [1]

- (ii) The dyes move through the agar by diffusion.

The scientists calculate the average rate of diffusion for dye X after 30 seconds as:

$$\frac{\text{distance travelled}}{\text{time taken}} = \frac{11}{30} = 0.37 \text{ mm/s}$$

Calculate the average rate of diffusion for dye Y after 30 seconds.

..... mm/s [2]
[Turn over

(b) Describe the direction of motion of particles during diffusion.

.....

 [2]

(c) Substances move into and out of cells by diffusion.

(i) State the part of the cell that controls the movement of substances in and out of the cell.
 [1]

(ii) Circle **two** substances that diffuse into cells for respiration.

carbon dioxide **fatty acids** **glucose**
oxygen **starch** **water**

[2]

(d) Table 4.1 shows some components of plant cells and their function.

Complete Table 4.1.

Table 4.1

component of plant cell	function
	contains cell sap to support the plant cell
cytoplasm	
	where photosynthesis occurs

[3]

[Total: 11]

5 (a) The list below shows the formulae of six molecules.



Identify which of the molecules from the list is:

(i) an ammonia molecule

..... [1]

(ii) a molecule used in the treatment of water

..... [1]

(iii) a molecule formed during the **incomplete** combustion of carbon-containing substances

..... [1]

(iv) the molecule of the gas that is 78% of clean dry air

..... [1]

(v) a molecule that contains four covalent bonds.

..... [1]

(b) Lime (calcium oxide) is made from limestone (calcium carbonate) by thermal decomposition.

(i) State the name of the other product of this reaction.

..... [1]

(ii) Calcium carbonate is not a fertiliser but is often added to soil.

Explain why calcium carbonate is often added to soil.

.....
 [1]

(iii) List the **three** essential elements needed in a fertiliser.

1

2

3

[2]

[Total: 9]

- 6 Bats use the reflection of sound waves to determine the position of objects.

Fig. 6.1 shows a bat, and a moth flying in front of the bat.

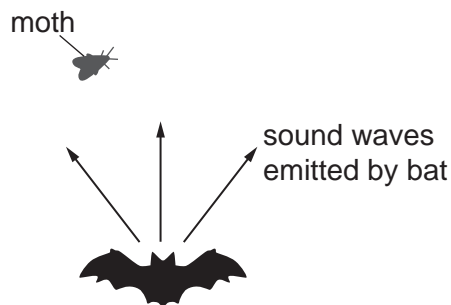

Fig. 6.1

- (a) State the name given to a reflected sound wave.

..... [1]

- (b) Some bats are able to detect ultraviolet radiation. Ultraviolet radiation is part of the electromagnetic spectrum.

- (i) On the incomplete electromagnetic spectrum shown in Fig. 6.2, place ultraviolet in the correct position.

	X-rays			infrared		radio waves
--	--------	--	--	----------	--	-------------

Fig. 6.2

[1]

- (ii) State which part of the electromagnetic spectrum has the lowest frequency.

..... [1]

- (c) A bat produces a sound wave with a frequency of 200 kHz and a wavelength of 0.0016 m.

- (i) Draw straight lines to link each wave term to its definition.

term	definition
amplitude	distance between the peaks on consecutive waves
frequency	maximum displacement of points on a wave
wavelength	number of waves passing a fixed point per second

[2]

(ii) Explain why a human cannot hear the sound emitted by the bat.

.....
..... [1]

(iii) The bat changes the frequency of the sound it produces from 200 kHz to 250 kHz.

State what happens to the pitch of the sound.

..... [1]

[Total: 7]

7 (a) Students in a school measure their hand-span.

Fig. 7.1 is a photograph showing the measurement that each student takes.

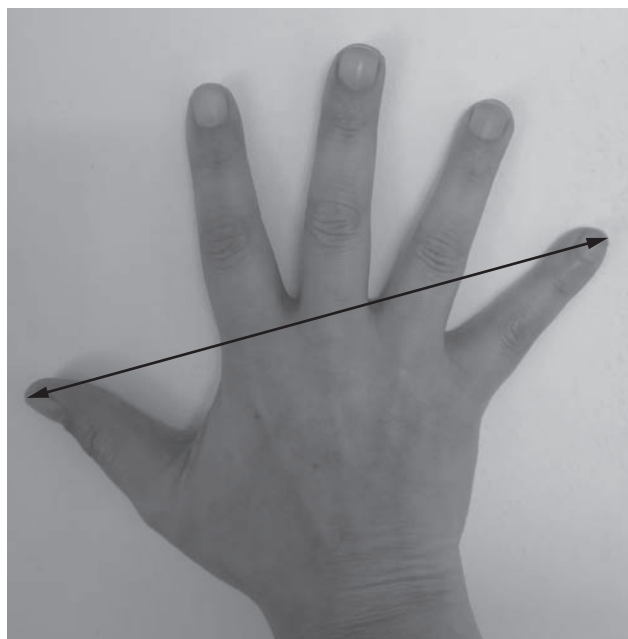

Fig. 7.1

Fig. 7.2 is a histogram showing the results.

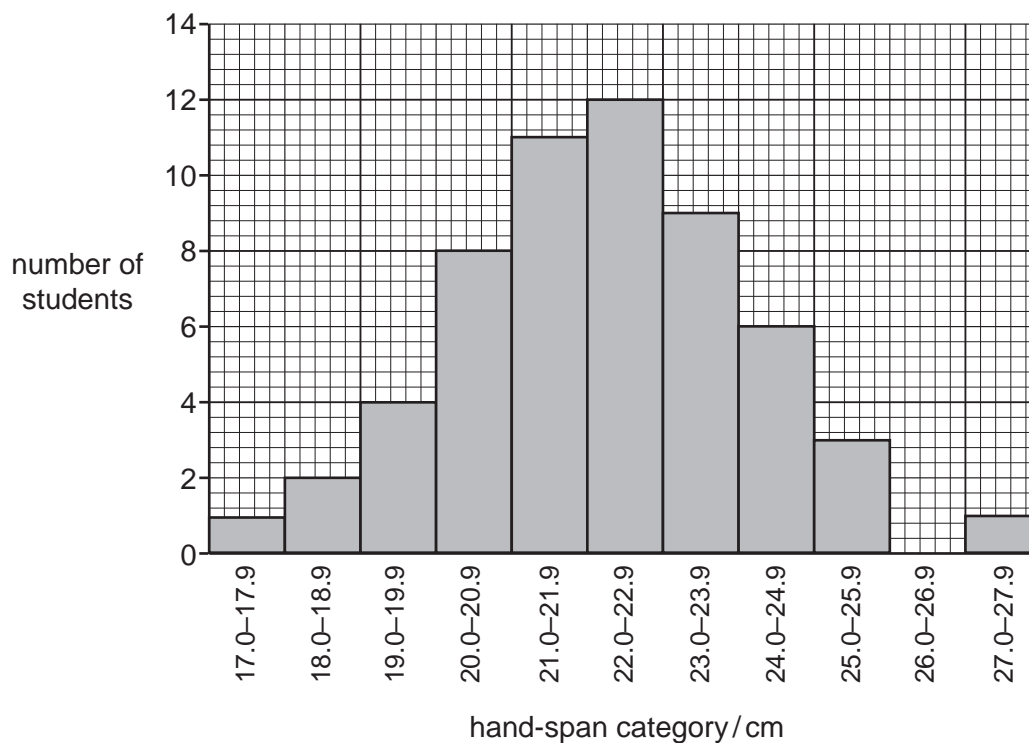

Fig. 7.2

(i) Determine which hand-span category has the most students.

..... cm [1]

- (ii) Determine the number of students with a hand-span of 19.0–19.9 cm.

..... [1]

- (iii) Histograms are used to display data that show continuous variation. What other evidence from Fig. 7.2 shows that hand-span is an example of continuous variation?

.....
 [1]

- (iv) State the name of **one** other example of continuous variation.

..... [1]

- (b) Fig. 7.3 is an incomplete Punnett square, genetic diagram.

- (i) Complete Fig. 7.3 to show how sex is inherited in humans.

		male sex chromosomes	
		X	Y
female sex chromosomes			

Fig. 7.3

[2]

- (ii) Use Fig. 7.3 to determine the ratio of male offspring to female offspring.

..... male : female [1]

(c) Several structures are involved in inheritance.

chromosomes DNA gene nucleus

Place structures from the list in order of size from smallest to largest.

smallest

↓

largest

.....

.....

.....

.....

[2]

[Total: 9]

- 8 (a) Potassium is an element in the Periodic Table.

Use numbers from the list to complete the sentences about potassium.
Each number may be used once, more than once or not at all.

1 2 3 8 19 20 39

Potassium is an element in group of the Periodic Table.

A potassium atom has a total of electrons.

A potassium ion has a positive charge of

[3]

- (b) Sodium and chlorine react to form sodium chloride.

Fig. 8.1 shows the electronic structure of a sodium atom and a chlorine atom.

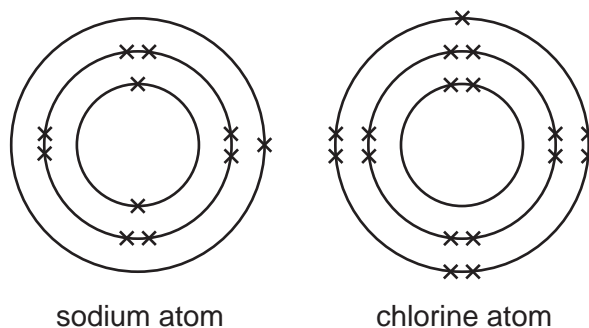

Fig. 8.1

Complete the diagrams in Fig. 8.2 to show the electronic structure of the ions in sodium chloride.

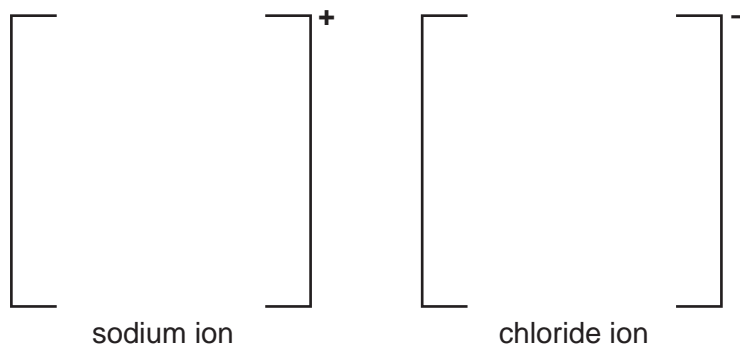

Fig. 8.2

[2]

(c) Fig. 8.3 shows the electrolysis of concentrated aqueous sodium chloride.

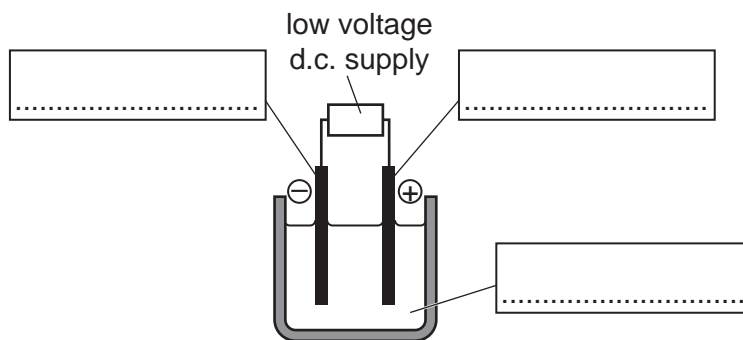

Fig. 8.3

(i) Complete Fig. 8.3 by labelling the:

- anode
- cathode
- electrolyte.

[2]

(ii) Hydrogen gas is one of the electrode products of this electrolysis.

State the name of the other electrode product.

..... [1]

(iii) Describe the chemical test for hydrogen gas. State the observation for a positive result.

test

observation

[2]

[Total: 10]

9 Fig. 9.1 shows an aircraft at rest on a runway.

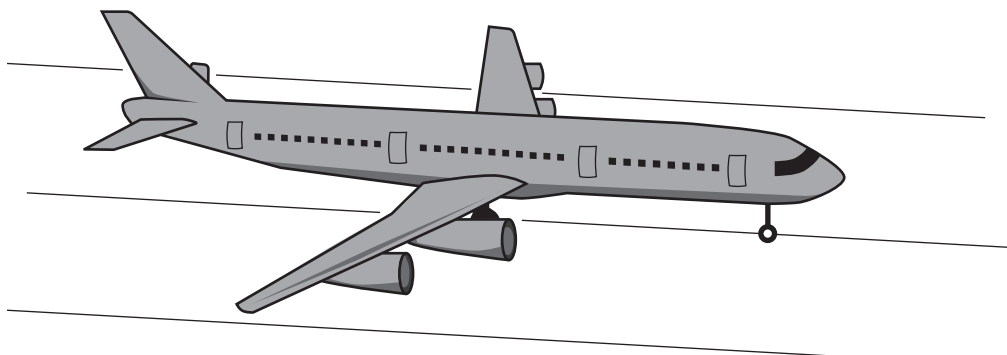

Fig. 9.1

(a) The mass of the aircraft is 400 000 kg.

Calculate the weight of the aircraft.
The gravitational field strength, g , is 10 N/kg.

weight = N [2]

(b) The aircraft starts from rest and accelerates along the straight runway.
The aircraft engines produce a constant horizontal thrust force of 1 200 000 N.
A constant frictional force of 500 000 N acts on the aircraft.

(i) Calculate the resultant horizontal force acting on the aircraft.

force = N [1]

(ii) Explain why the aircraft accelerates.

.....
..... [1]

- (c) Fig. 9.2 shows a TV monitor in the cabin of the aircraft and the energy transferred each second by the monitor.

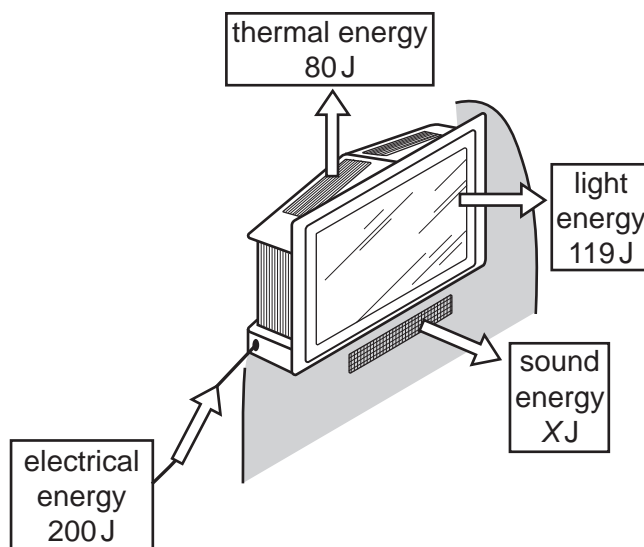

Fig. 9.2

- (i) The number of joules of sound energy transferred per second is shown as XJ .

Calculate the value of X .

$X = \dots\dots\dots J$ [1]

- (ii) The monitor has a resistance of 1900Ω .
The current passing through the monitor when in use is $0.060A$.

Calculate the potential difference across the monitor.
State the unit of your answer.

potential difference = $\dots\dots\dots$ unit $\dots\dots\dots$ [3]

- (iii) The current of 0.060A is the same as 60mA.
The fuse in the electrical supply to the monitor has to be replaced.
Several fuse ratings are available.

10 mA 50 mA 100 mA 250 mA

State which fuse is the correct choice.

Explain your answer.

fuse = mA

explanation

.....

.....

[2]

[Total: 10]

10 (a) Fig. 10.1 is a diagram of the alimentary canal and associated organs in a human.

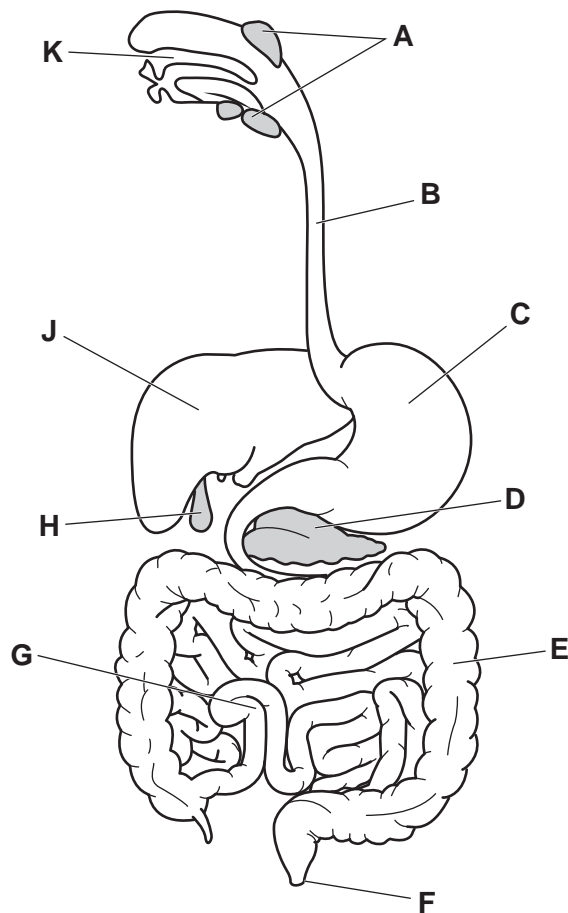

Fig. 10.1

(i) Identify the letter in Fig. 10.1 that represents the part where:

ingestion occurs

egestion occurs

mechanical digestion occurs

saliva is produced.

[4]

(ii) State the name of the parts labelled **D** and **H** in Fig. 10.1.

D

H

[2]

(b) Table 10.1 shows some features of absorption and assimilation.

Place ticks (✓) in the boxes to show the features of each process.

Table 10.1

process	feature		
	movement of digested food molecules	movement into blood	movement into cells
absorption			
assimilation			

[3]

(c) Draw a line to link each component to its dietary importance.

One has been done for you.

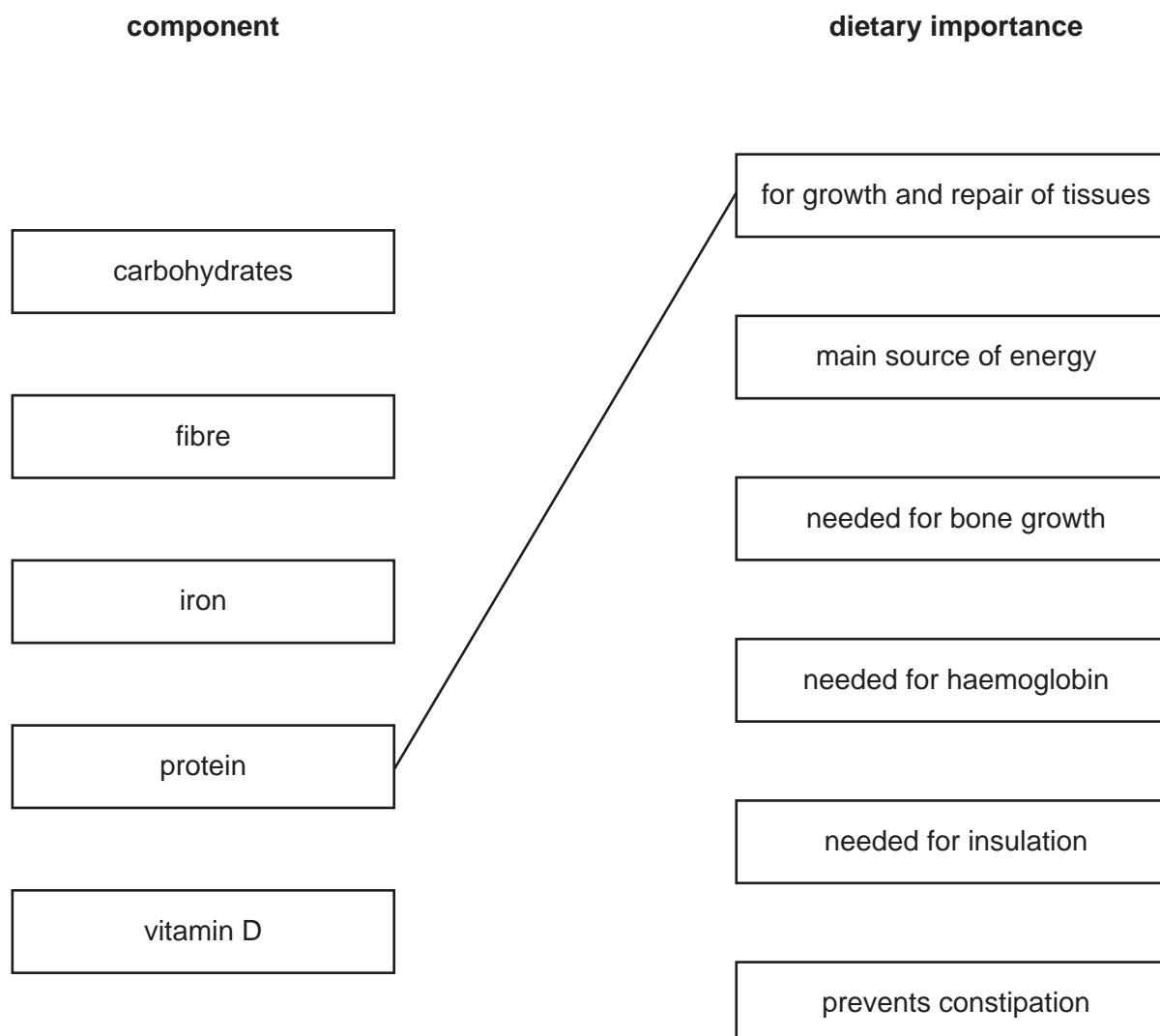

[4]

[Total: 13]

11 Fig. 11.1 shows the apparatus and reagents used to make a salt.

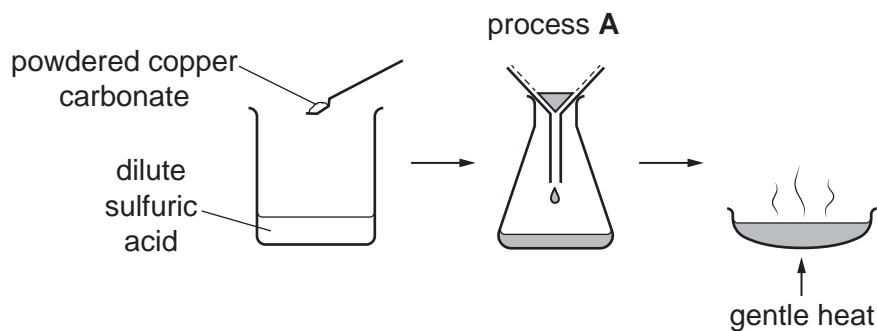

Fig. 11.1

- (a) (i) State the name of process **A** shown in Fig. 11.1.
 [1]
- (ii) State the name of the salt made in this experiment.
 [1]
- (iii) Carbon dioxide gas is also made.
 Explain why the bonds between the carbon atoms and the oxygen atoms in carbon dioxide are covalent.

 [1]
- (iv) The temperature of the reacting mixture increases during the reaction.
 State the name given to all chemical reactions that release heat.
 [1]
- (v) The experiment is repeated using large pieces of copper carbonate instead of powdered copper carbonate.
 State what happens to the rate of reaction.

 [1]

- (b) Copper carbonate is green. Copper is a transition metal.
One of the properties of transition metals is that they form coloured compounds.

State **two** other properties of transition metals which are not properties of all metals.

1

2

[2]

- (c) Brass is a mixture containing copper and zinc.

- (i) State the name given to a mixture of metals.

..... [1]

- (ii) State **one** advantage of brass compared to copper.

.....

..... [1]

[Total: 9]

- 12 An astronomer observes a large meteorite, a rock from outer space. The astronomer uses a telescope which contains mirrors.

Fig. 12.1 shows the image of the meteorite seen in the mirror by the astronomer.



Fig. 12.1

- (a) Select **two** words or phrases from the list to describe the characteristics of an image formed by a single plane mirror.

diminished enlarged inverted same size upright

1

2

[2]

- (b) The meteorite enters the Earth's atmosphere.

Fig. 12.2 is a speed-time graph for the meteorite as it approaches Earth.

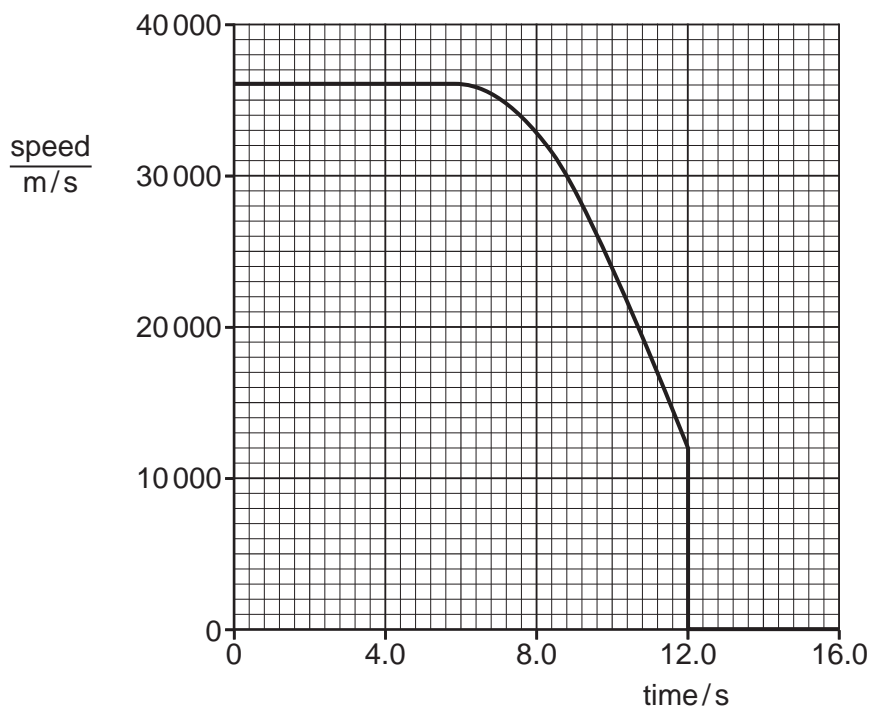

Fig. 12.2

- (i) On Fig. 12.2, label with an **S** a point when the meteorite is slowing down. [1]

- (ii) State the form of energy lost by the meteorite as it slows down.

..... [1]

- (iii) Use Fig. 12.2 to determine the maximum speed of the meteorite.

speed m/s [1]

- (c) The mass of the meteorite is 22500 kg.
The density of the meteorite is 7500 kg/m^3 .

(i) Calculate the volume of the meteorite.

volume = m^3 [2]

(ii) A scientist suggests that the meteorite contains metallic iron.

Suggest a simple way for the scientist to test for iron in an object found on Earth.

.....
..... [1]

- (d) The meteorite's temperature is 1500°C when it falls into the sea.
The meteorite loses thermal energy to the water.

(i) State the main method of thermal energy transfer from the meteorite into the water.

..... [1]

(ii) Some of the seawater evaporates.

Describe the process of evaporation in terms of the movement and energy of water molecules.

.....
.....
..... [2]

- (iii) The meteorite is a solid and the seawater is a liquid.

Draw more circles in the boxes in Fig. 12.3 to show the arrangement and separation of particles in a solid and in a liquid.

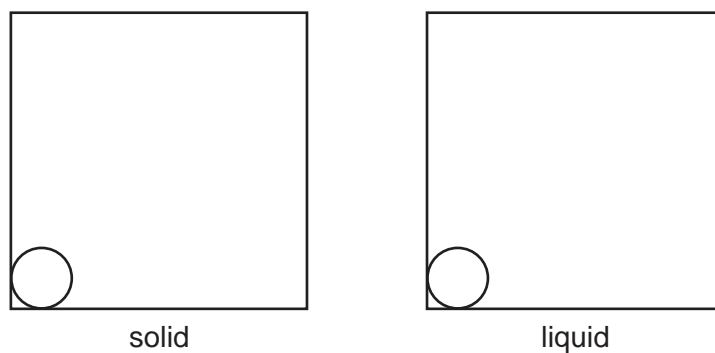

Fig. 12.3

[2]

[Total: 13]

BLANK PAGE

Permission to reproduce items where third-party owned material protected by copyright is included has been sought and cleared where possible. Every reasonable effort has been made by the publisher (UCLES) to trace copyright holders, but if any items requiring clearance have unwittingly been included, the publisher will be pleased to make amends at the earliest possible opportunity.

To avoid the issue of disclosure of answer-related information to candidates, all copyright acknowledgements are reproduced online in the Cambridge Assessment International Education Copyright Acknowledgements Booklet. This is produced for each series of examinations and is freely available to download at www.cambridgeinternational.org after the live examination series.

Cambridge Assessment International Education is part of Cambridge Assessment. Cambridge Assessment is the brand name of the University of Cambridge Local Examinations Syndicate (UCLES), which is a department of the University of Cambridge.

The Periodic Table of Elements

Group									
I	II	III	IV	V	VI	VII	VIII		
3 Li lithium 7	4 Be beryllium 9	5 B boron 11	6 C carbon 12	7 N nitrogen 14	8 O oxygen 16	9 F fluorine 19	10 Ne neon 20		
11 Na sodium 23	12 Mg magnesium 24	13 Al aluminium 27	14 Si silicon 28	15 P phosphorus 31	16 S sulfur 32	17 Cl chlorine 35.5	18 Ar argon 40		
19 K potassium 39	20 Ca calcium 40	21 Sc scandium 45	22 Ti titanium 48	23 V vanadium 51	24 Cr chromium 52	25 Mn manganese 55	26 Fe iron 56	27 Co cobalt 59	28 Ni nickel 59
37 Rb rubidium 85	38 Sr strontium 88	39 Y yttrium 89	40 Zr zirconium 91	41 Nb niobium 93	42 Mo molybdenum 96	43 Tc technetium —	44 Ru ruthenium 101	45 Rh rhodium 103	46 Pd palladium 106
55 Cs caesium 133	56 Ba barium 137	57-71 lanthanoids	72 Hf hafnium 178	73 Ta tantalum 181	74 W tungsten 184	75 Re rhenium 186	76 Os osmium 190	77 Ir iridium 192	78 Pt platinum 195
87 Fr francium —	88 Ra radium —	89-103 actinoids	104 Rf rutherfordium —	105 Db dubnium —	106 Sg seaborgium —	107 Bh bohrium —	108 Hs hassium —	109 Mt meitnerium —	110 Ds darmstadtium —
							111 Rg roentgenium —	112 Cn copernicium —	114 Fl flerovium —
							116 Lv livermorium —	118 Og oganeson —	

1
H
hydrogen
1

Key
atomic number
atomic symbol
name
relative atomic mass

57 La lanthanum 139	58 Ce cerium 140	59 Pr praseodymium 141	60 Nd neodymium 144	61 Pm promethium —	62 Sm samarium 150	63 Eu europium 152	64 Gd gadolinium 157	65 Tb terbium 159	66 Dy dysprosium 163	67 Ho holmium 165	68 Er erbium 167	69 Tm thulium 169	70 Yb ytterbium 173	71 Lu lutetium 175
89 Ac actinium —	90 Th thorium 232	91 Pa protactinium 231	92 U uranium 238	93 Np neptunium —	94 Pu plutonium —	95 Am americium —	96 Cm curium —	97 Bk berkelium —	98 Cf californium —	99 Es einsteinium —	100 Fm fermium —	101 Md mendelevium —	102 No nobelium —	103 Lr lawrencium —

lanthanoids

actinoids

The volume of one mole of any gas is 24 dm³ at room temperature and pressure (r.t.p.).