



Cambridge IGCSE™

CANDIDATE
NAME

CENTRE
NUMBER

--	--	--	--	--

CANDIDATE
NUMBER

--	--	--	--



CO-ORDINATED SCIENCES

0654/32

Paper 3 Theory (Core)

October/November 2020

2 hours

You must answer on the question paper.

No additional materials are needed.

INSTRUCTIONS

- Answer **all** questions.
- Use a black or dark blue pen. You may use an HB pencil for any diagrams or graphs.
- Write your name, centre number and candidate number in the boxes at the top of the page.
- Write your answer to each question in the space provided.
- Do **not** use an erasable pen or correction fluid.
- Do **not** write on any bar codes.
- You may use a calculator.
- You should show all your working and use appropriate units.

INFORMATION

- The total mark for this paper is 120.
- The number of marks for each question or part question is shown in brackets [].
- The Periodic Table is printed in the question paper.

This document has **32** pages. Blank pages are indicated.

1 (a) Fig. 1.1 is a diagram of a food web in the sea.

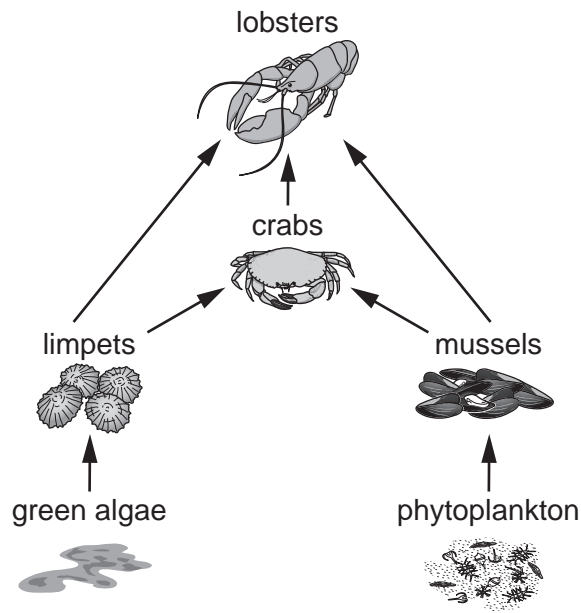

Fig. 1.1

(i) Construct a food chain from the food web shown in Fig. 1.1.

Your food chain must include **four** organisms.

..... [2]

(ii) Table 1.1 shows some terms that can be used to describe organisms in the food web shown in Fig. 1.1.

Place ticks (✓) in the boxes to show **all** the terms that describe each organism.

Table 1.1

	carnivore	herbivore	producer	primary consumer	tertiary consumer
crabs					
limpets					
lobsters					
phytoplankton					

[4]

(iii) A disease kills all the limpets in the food web shown in Fig. 1.1.

State why:

the population of green algae increases

.....
.....

the immediate population of mussels decreases.

.....
.....

[2]

(b) Disease can cause organisms to become extinct.

Deforestation is another reason for extinction of organisms.

List **two other** undesirable effects of deforestation.

1

2

[2]

[Total: 10]

2 The halogens chlorine, bromine and iodine are in Group VII of the Periodic Table.

(a) (i) Table 2.1 shows the melting points and boiling points of chlorine, bromine and iodine.

Complete Table 2.1.

Table 2.1

halogen	melting point /°C	boiling point /°C	solid, liquid or gas at 20°C
.....	-7	+59
.....	-101	-34
.....	+114	+184

[2]

(ii) Describe **one other** trend in the properties of the Group VII elements.

.....
 [1]

(b) In a naturally occurring sample of chlorine, one of the atoms contains **17 protons** and **18 neutrons**.

The sentences about chlorine are either correct or incorrect.

For each sentence, write a tick (✓) if it is correct or a cross (X) if it is incorrect.

The protons are contained in the nucleus.

The nucleon number (mass number) of the atom is 18.

A **molecule** of chlorine contains 34 protons.

All chlorine atoms contain 18 neutrons.

All chlorine atoms contain 17 protons.

[2]

(c) Sodium reacts with chlorine to make sodium chloride.

During the reaction, a sodium atom transfers one electron to a chlorine atom.

(i) State the **type** of chemical bonding in sodium chloride.

..... [1]

(ii) Explain in terms of electrical charges why sodium and chloride particles are strongly bonded in sodium chloride.

.....

.....

..... [2]

(d) A student knows that a white solid is either sodium chloride or potassium chloride.

Describe a test she can do to identify whether the solid is sodium chloride or potassium chloride.

Include the results she can expect.

test

result for sodium chloride

result for potassium chloride

[2]

[Total: 10]

- 3 (a) A skydiver jumps from an aircraft high above the ground.

Fig. 3.1 shows the speed–time graph of his descent.

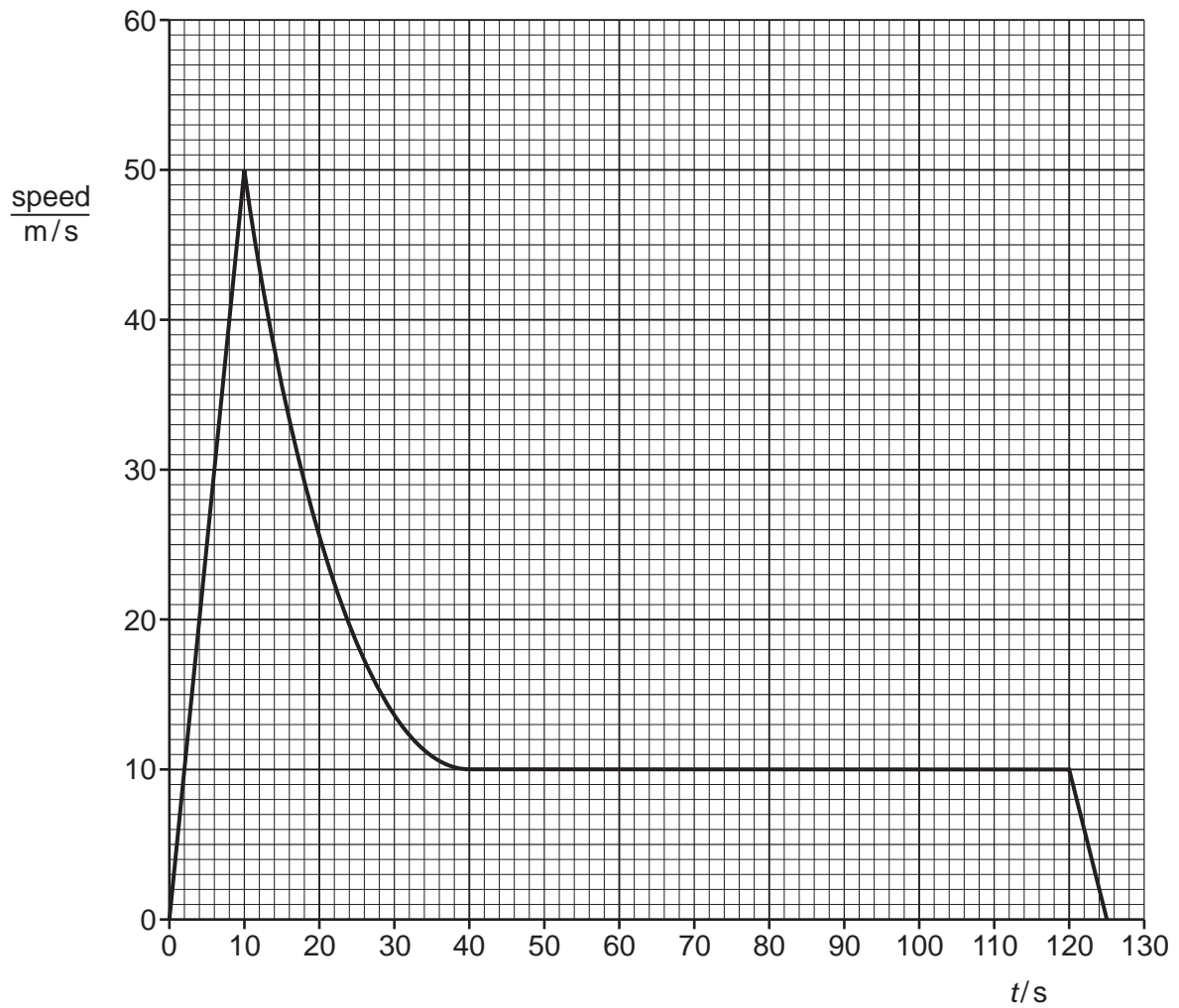

Fig. 3.1

Use the graph in Fig. 3.1 to calculate how far the skydiver falls from time $t = 0s$ to $t = 10s$.

distance = m [2]

(b) When the skydiver opens the parachute at $t = 10$ s, his speed decreases.

Name the force that causes this decrease in speed.

..... [1]

(c) The skydiver has a mass of 85 kg.

His weight is 850 N.

(i) State the size of the upwards force on the skydiver at $t = 80$ s.

Explain your answer.

size of upwards force = N

explanation

..... [2]

(ii) State the value of the gravitational field strength g that is used to determine the weight of the skydiver in (c).

Give the units of g .

value of $g =$ units

[2]

(d) The skydiver lands in a pit full of sand. The dimensions of the sand pit are shown in Fig. 3.2.

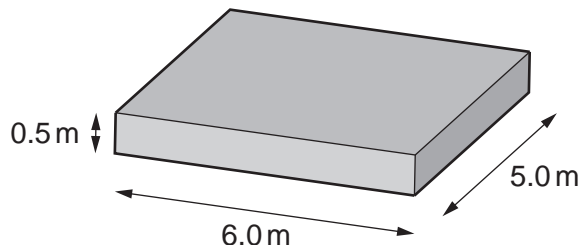

Fig. 3.2

The density of sand is 1800 kg/m^3 .

Calculate the mass of the sand in the pit.

mass = kg [3]

[Total: 10]

- 4 (a) In Fig. 4.1, the boxes on the left show some of the components of a balanced diet for an adult. The boxes on the right show some principal sources of these components.

Draw **four** lines to link each component with its principal source.

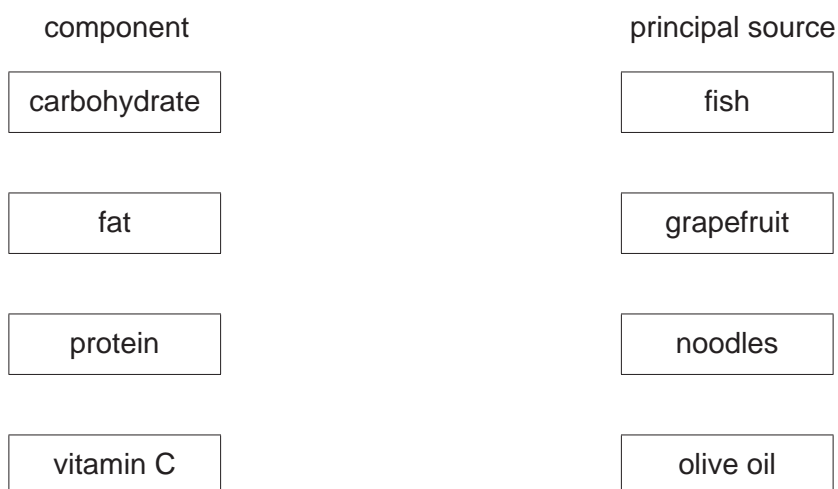

Fig. 4.1

[3]

- (b) A person has to choose between two different menus, **A** and **B**.

Fig. 4.2 shows each menu.

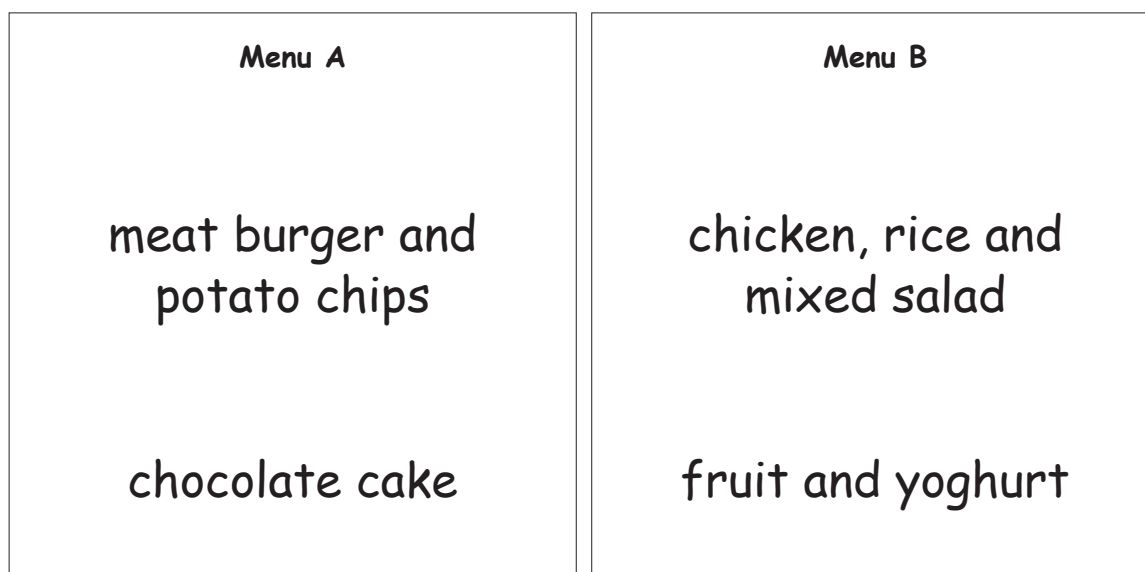

Fig. 4.2

- (i) A doctor advises a patient to eat menu **B** rather than menu **A**.

Suggest **two** reasons why.

- 1
-
- 2
-
- [2]

- (ii) Both meals contain water.

Table 4.1 lists some statements.

Place a tick (✓) to show the statement that describes why water is needed by the body.

Table 4.1

as a reactant for respiration	
as a solvent	
to carry genetic information	
to carry oxygen in the blood	
to provide insulation for the body	

[1]

- (c) The food we ingest is absorbed and assimilated inside the body.

- (i) State where ingestion occurs.

..... [1]

- (ii) Describe **one** similarity and **one** difference between absorption and assimilation.

similarity

.....

difference

.....

[2]

- (d) Nutrition is one of the characteristics of living things.

Name **two other** characteristics.

1

2

[2]

[Total: 11]

5 Aluminium is used in industry to make many different products.

(a) Fig. 5.1 shows stages in the production of aluminium food containers.

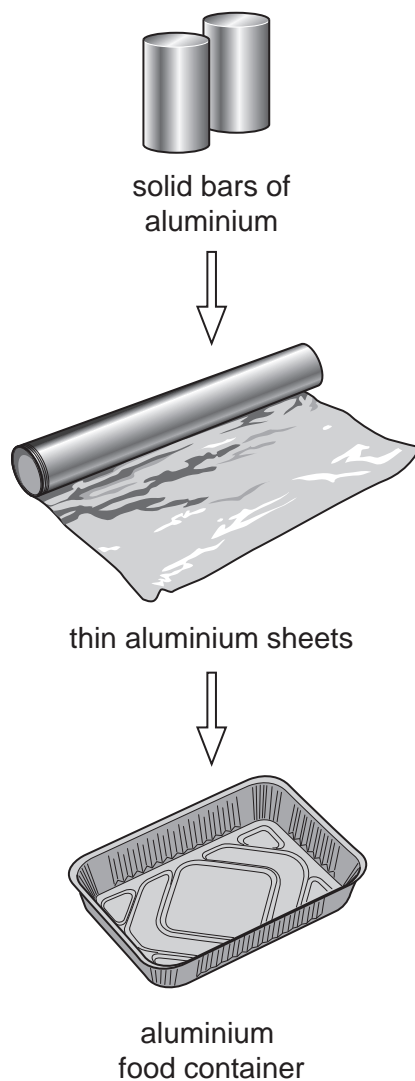

Fig. 5.1

(i) State the **physical** property of aluminium which allows it to be made into thin sheets.

..... [1]

(ii) Describe the property of aluminium which means it is safe to use for food containers.

.....
..... [1]

(b) Table 5.1 shows information about the composition of an aluminium alloy, **A**.

Table 5.1

element	mass in 100.0g of alloy A
aluminium	
copper	4.0
magnesium	0.6
chromium	0.7
silicon	0.5

(i) Calculate the mass of aluminium in 100.0g of alloy **A**.

mass = g [1]

(ii) Identify the **two** transition elements in alloy **A**.

A copy of the Periodic Table appears on page 32.

..... and [1]

(iii) Aluminium alloys and pure aluminium have low densities.

Suggest why aircraft parts are made from aluminium alloys rather than from pure aluminium.

.....
 [1]

(c) Aluminium is extracted from its ore using electrolysis.

Fig. 5.2 shows how this is done in industry.

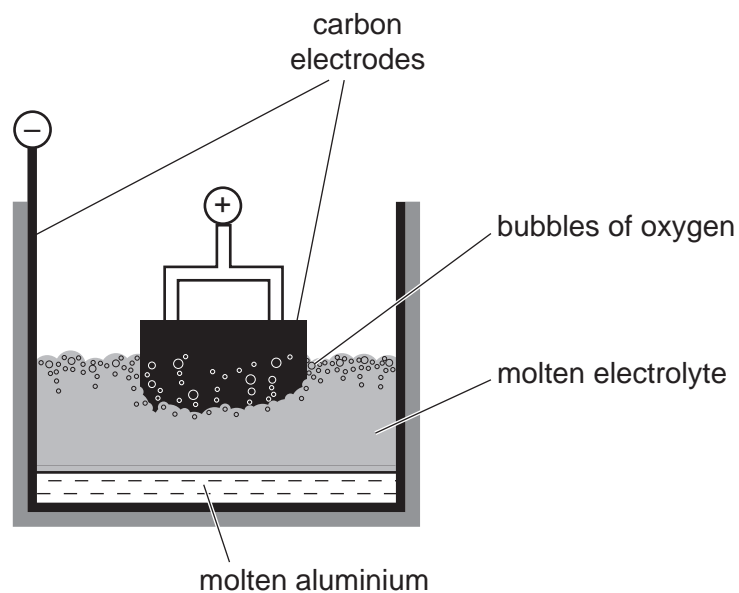

Fig. 5.2

(i) Aluminium forms at the negative electrode.

The negative electrode is the carbon lining of the apparatus.

State the name of this electrode.

..... [1]

(ii) Oxygen gas is made at the positive electrode.

The positive electrode is made of carbon and is very hot.

Suggest, in terms of a chemical reaction, why the positive electrode becomes smaller.

.....

 [2]

(iii) State the name of the ore from which aluminium is extracted.

..... [1]

(iv) Aluminium ore is removed from the Earth's crust and is not replaced.

Describe **one** way in which humans can reduce the rate at which aluminium ore is being used.

.....
 [1]

[Total: 10]

- 6 (a) A torch (flash light) contains a cell, a switch and a lamp connected in series.
- (i) Complete the circuit diagram in Fig. 6.1. The lamp has been drawn for you.



Fig. 6.1

[2]

- (ii) The cell is a store of chemical energy.

Complete the sentences to describe the energy transfers when the circuit is switched on and the lamp is lit.

In the cell energy is transferred to electrical energy in the circuit.

Electrical energy in the circuit is transferred to energy and energy emitted from the lamp.

[2]

- (iii) The lamp has a resistance of $8.0\ \Omega$ and the potential difference (p.d.) across the lamp is 12 V.

Calculate the current in the lamp.

current = A [2]

(b) (i) Name the instrument used to measure current in a circuit.

.....

[1]

(ii) The wires in the circuit are made of copper.

State the name of the particles that flow when there is a current in the wires.

.....

[1]

(c) A student connects a $3\ \Omega$ and a $4\ \Omega$ resistor in series.

Calculate the combined resistance of these **two** resistors in series.

resistance = Ω [1]

[Total: 9]

7 (a) Fig. 7.1 is a diagram of the human gas exchange system.

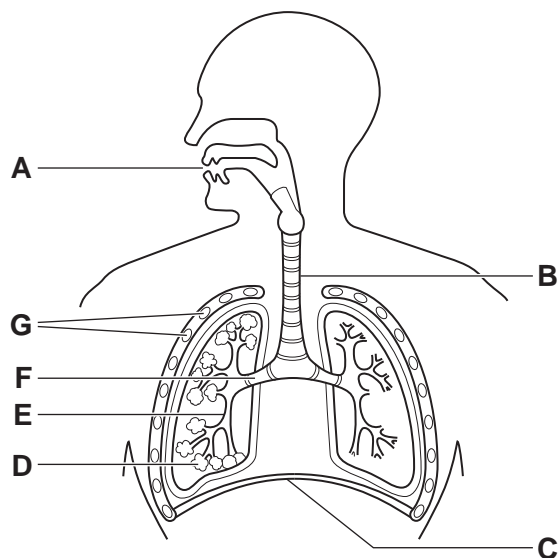

Fig. 7.1

(i) State the letters in Fig. 7.1 that identify the:

- bronchus
- diaphragm
- ribs
- trachea.

[4]

(ii) Table 7.1 contains some statements.

Place ticks (✓) next to the statements that correctly describe diffusion.

Table 7.1

Diffusion occurs due to random movement of particles.	
Particles move up a concentration gradient.	
Substances move into cells by diffusion.	
The net movement of particles is from low to high concentration.	
Water does not diffuse into cells.	

[2]

(b) Inspired air contains more oxygen than expired air.

Oxygen is used in the process of respiration.

(i) State **two other** ways that inspired air is different from expired air.

1

2

[2]

(ii) State why respiration enables protein synthesis to take place.

.....

..... [1]

(iii) State the substance that reacts with oxygen in aerobic respiration.

.....

[1]

[Total: 10]

8 Fig. 8.1 shows hydrogen burning in air.

Water is made during the reaction.

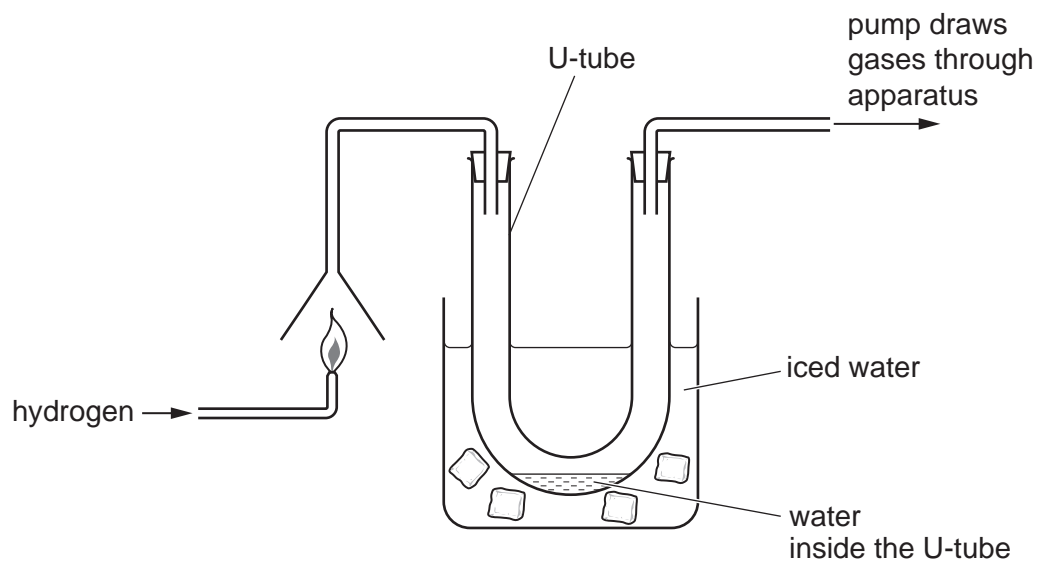

Fig. 8.1

(a) Describe **one** test and its positive result to show that the liquid in the U-tube is water.

test

.....

result

[2]

(b) Look at the symbol equation for the reaction of hydrogen burning.

This equation is **not** balanced.



(i) Explain why this equation is **not** balanced.

.....

..... [1]

(ii) Rewrite the equation correctly balanced.

..... [1]

(c) Fig. 8.2 shows the electrons in an atom of hydrogen and an atom of oxygen.

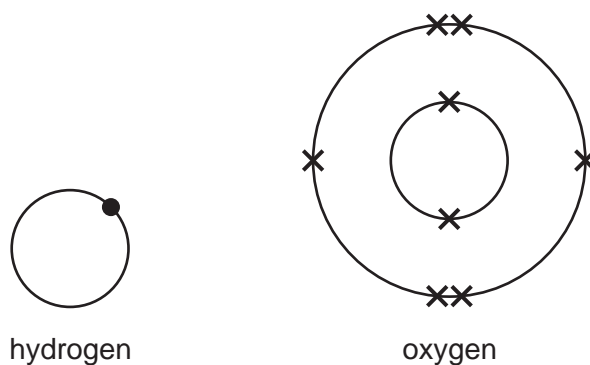

Fig. 8.2

In the space below, draw the dot-and-cross diagram for a water molecule, H_2O .

In your diagram, show:

- the chemical symbols of the elements
- all of the outer shell electrons.

[2]

(d) A student places 100 cm^3 of aqueous potassium chloride into the distillation apparatus shown in Fig. 8.3.

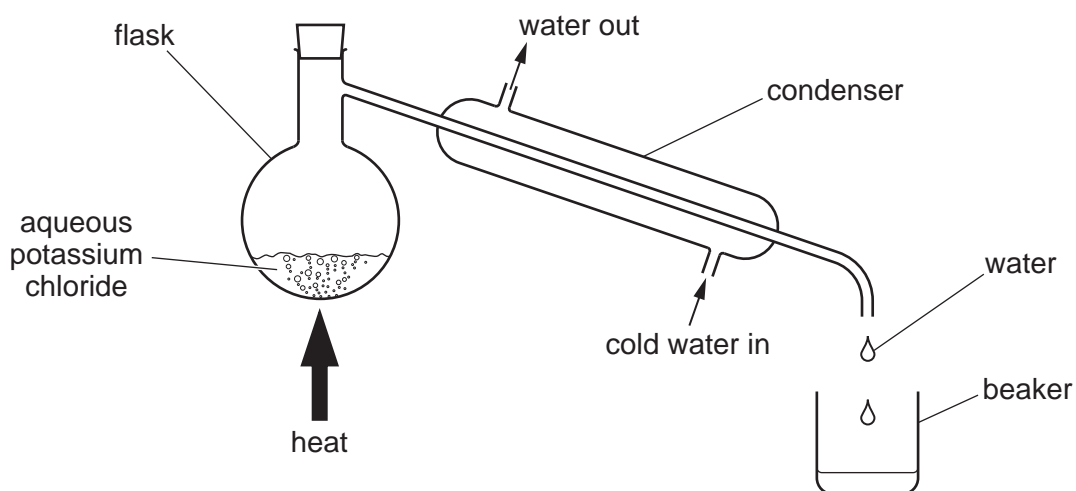

Fig. 8.3

She boils the solution gently until the flask contains only solid potassium chloride.

- (i) Explain why it is possible to separate water from potassium chloride by distillation.

In your answer, use ideas about:

- types of bonding
- boiling points.

.....

 [2]

- (ii) The mass of solid potassium chloride in 100 cm^3 of aqueous potassium chloride is 2.5 g.
 Calculate the concentration of potassium chloride, in g/dm^3 , in this aqueous solution.

concentration = g/dm^3 [1]

- (iii) The student tests the purity of the water in the beaker in Fig. 8.3.

Describe a test that she can use to show whether or not the water in the beaker contains any chloride ions.

test

.....

result if chloride ions are present

..... [2]

[Total: 11]

9 (a) A building is kept warm by heating its solid concrete floor.

(i) Describe the change in the motion of molecules in a solid as the temperature rises.

..... [1]

(ii) Some water spills onto the warm floor and evaporates.

Describe evaporation in terms of the motion of the water molecules.

.....
 [2]

(b) Thermal energy from the warm floor is transferred to the air which rises.

State the name of this process.

..... [1]

(c) An infrared camera is used to measure the rise in temperature of the concrete floor.

Place infrared into the incomplete electromagnetic spectrum in Fig. 9.1.

gamma rays		ultraviolet				radio waves
---------------	--	-------------	--	--	--	----------------

Fig. 9.1

[1]

(d) A worker in the building is using a hammer.

Hammering on concrete produces sound waves.

(i) Label with the letter **A** the double-headed arrow on Fig. 9.2 that shows the amplitude of the sound wave.

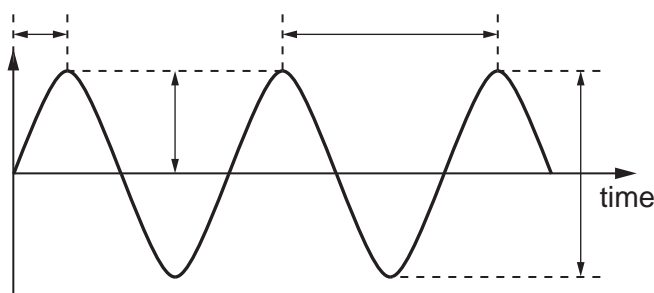

Fig. 9.2

[1]

(ii) State the approximate range of audible frequencies for a healthy human ear.

from Hz to Hz [1]

(e) The roof of the building is fitted with solar cells.

State **one** advantage and **one** disadvantage of generating electricity using solar cells apart from cost.

advantage

disadvantage

[2]

[Total: 9]

10 (a) Adrenaline is released in 'flight or fight' situations.

The concentration of adrenaline in the blood was monitored in three different people for 24 hours.

The results are shown in Fig. 10.1.

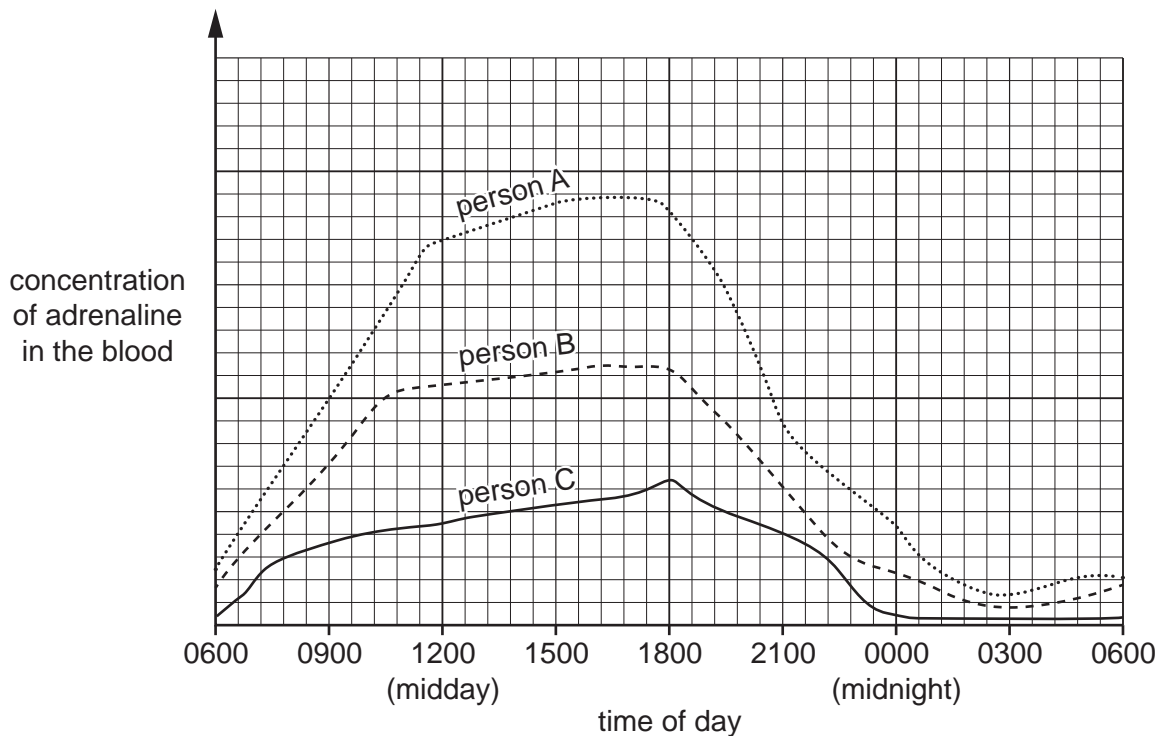

Fig. 10.1

(i) Suggest which person is under the most stress during this time.

Give a reason for your answer.

person

reason

[1]

(ii) State the time with the lowest release of adrenaline for all three people.

..... [1]

(iii) Describe **two** effects of adrenaline on the body.

- 1
-
- 2
-
- [2]

(iv) State which part of the blood transports hormones such as adrenaline.

..... [1]

(b) Table 10.1 shows the number of new infections of human immunodeficiency virus (HIV) in one country in the years 2002 and 2009.

Table 10.1

year	number of new HIV infections
2002	6980
2009	3100

(i) Calculate the decrease in new infections between 2002 and 2009.

..... [1]

(ii) Describe **two** methods of transmission of HIV.

- 1
-
- 2
-
- [2]

(iii) State the name of the deficiency syndrome that HIV can lead to.

..... [1]

[Total: 9]

11 (a) Fig. 11.1 shows the molecular structures of four carbon compounds, **A**, **B**, **C** and **D**.

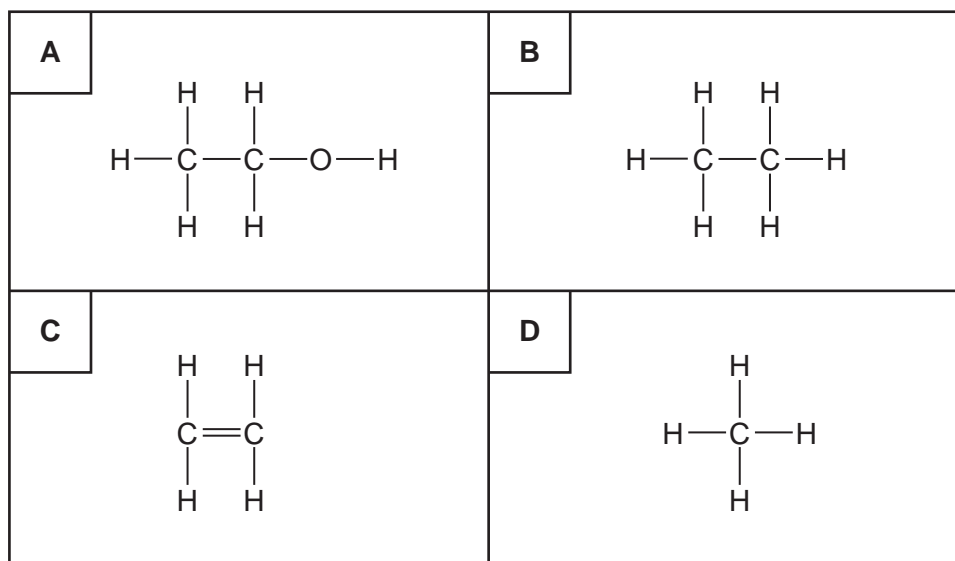

Fig. 11.1

(i) State which of the compounds are alkanes.

Explain your answer.

compounds

explanation

.....
.....

[2]

(ii) Fig. 11.2 shows two bottles, **E** and **F**, containing carbon compounds.

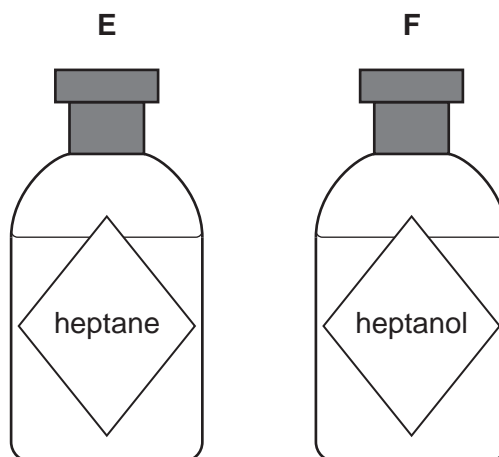

Fig. 11.2

State which bottle contains a hydrocarbon.

Explain your answer.

bottle

explanation

[1]

(b) Ethene is made when ethanol vapour passes over a heated catalyst.

Fig. 11.3 shows apparatus used to produce ethene from ethanol.

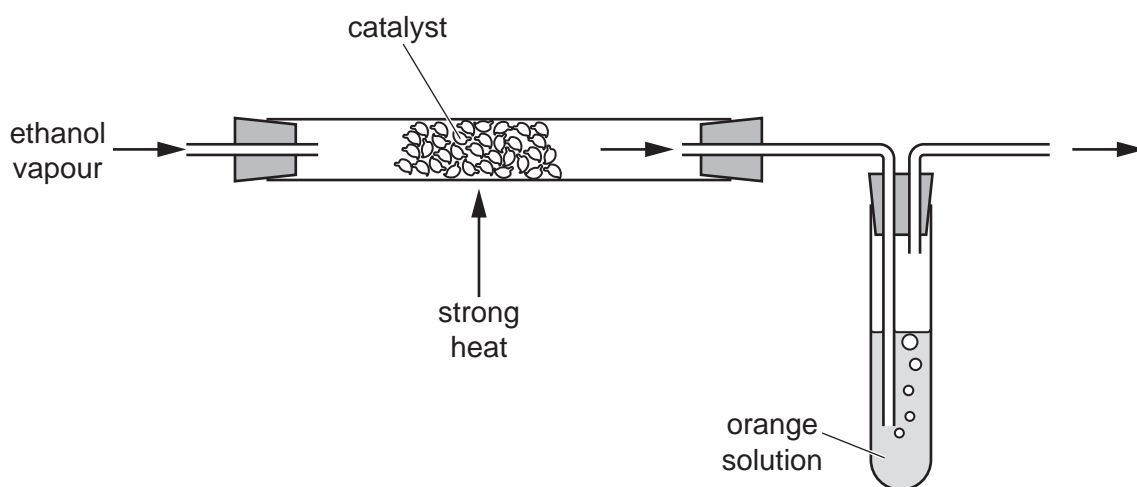

Fig. 11.3

(i) Suggest the purpose of the catalyst in this reaction.

.....
 [1]

(ii) The ethene passes through an orange solution which becomes colourless.

Identify the orange solution.

..... [1]

(iii) An ethene molecule is described as unsaturated.

Explain why.

.....
 [1]

(c) Fig. 11.4 shows an ethanol burner.

The balance measures the mass of the burner and ethanol.

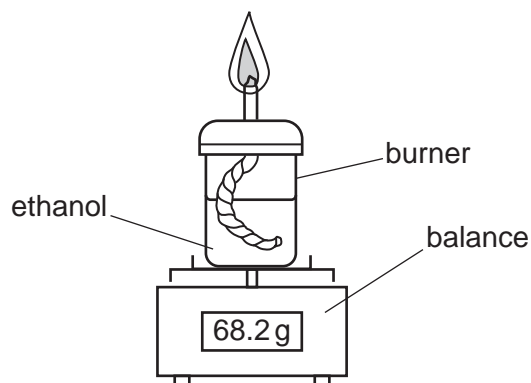
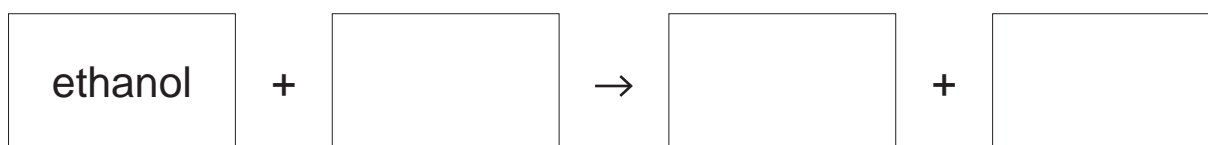

Fig. 11.4

(i) Complete the **word** equation for the complete combustion of ethanol.



[2]

(ii) Predict how the balance reading changes while the ethanol is burning.

Explain your answer.

change

explanation

.....

[1]

[Total: 9]

BLANK PAGE

12 (a) Fig. 12.1 shows a block of glass with a ray of light passing through it.

The ray of light is passing from the air into the glass.

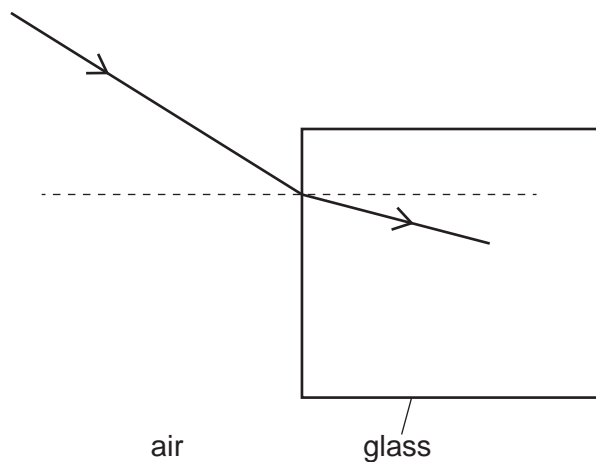

Fig. 12.1

- (i) On Fig. 12.1, label the angle of incidence with the letter i and the angle of refraction with the letter r . [1]
- (ii) On Fig. 12.1, complete the diagram to show how the ray of light continues through the glass and out into the air. [2]
- (b) Fig. 12.2 shows rays of light from an object projected onto a screen through a thin converging lens.

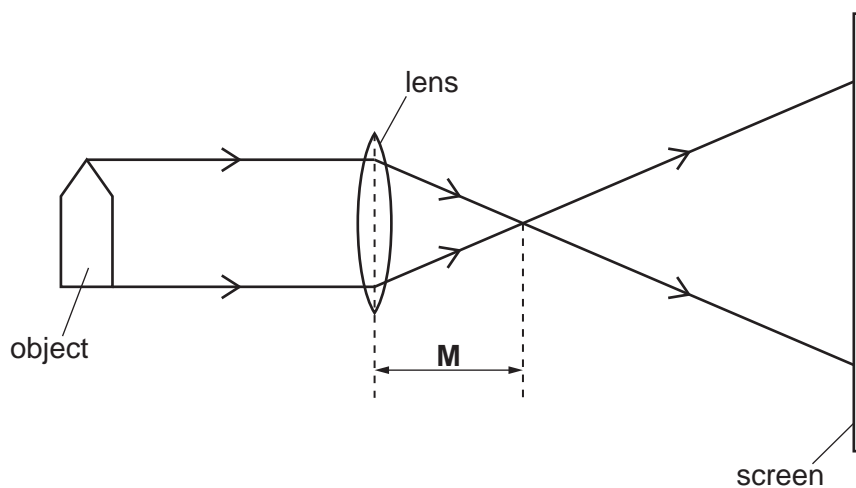

Fig. 12.2

- (i) State the name of the distance M .

.....

[1]

(ii) Circle **two** words or phrases that correctly describe the image on the screen.

diminished **enlarged** **inverted** **same size** **upright** [2]

(c) A robot is used to collect samples of radioactive material from a nuclear storage facility.

(i) Explain why the robotic vehicle is more suitable to collect the radioactive material than a human being.

.....
.....
..... [2]

Fig. 12.3 is a graph of the radioactive decay curve for a sample of the radioactive material.

(ii) Use the graph in Fig. 12.3 to determine the half-life of the sample.

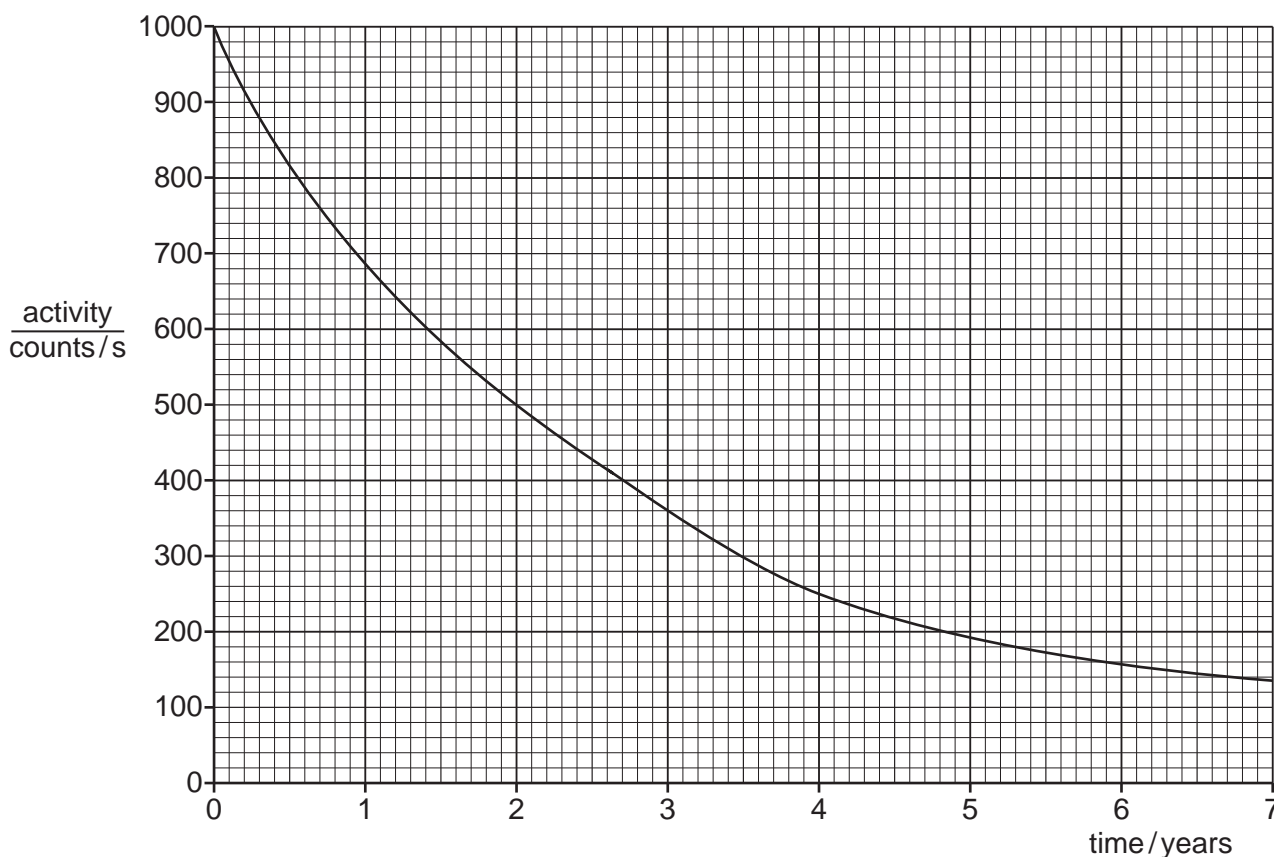

Fig. 12.3

half-life = years [2]

(d) The robot has a d.c. motor.

State **two** ways in which the turning effect of the current-carrying coil in the magnetic field of a d.c. motor can be increased.

1

2

[2]

[Total: 12]

BLANK PAGE

The Periodic Table of Elements

Group																																																																																			
I	II																III	IV	V	VI	VII	VIII																																																													
3 Li lithium 7	4 Be beryllium 9	<div style="border: 1px solid black; padding: 5px; display: inline-block;"> Key atomic number name relative atomic mass </div>																2 He helium 4																																																																	
11 Na sodium 23	12 Mg magnesium 24	1 H hydrogen 1	5 B boron 11	6 C carbon 12	7 N nitrogen 14	8 O oxygen 16	9 F fluorine 19	10 Ne neon 20	13 Al aluminium 27	14 Si silicon 28	15 P phosphorus 31	16 S sulfur 32	17 Cl chlorine 35.5	18 Ar argon 40	19 K potassium 39	20 Ca calcium 40	21 Sc scandium 45	22 Ti titanium 48	23 V vanadium 51	24 Cr chromium 52	25 Mn manganese 55	26 Fe iron 56	27 Co cobalt 59	28 Ni nickel 59	29 Cu copper 64	30 Zn zinc 65	31 Ga gallium 70	32 Ge germanium 73	33 As arsenic 75	34 Se selenium 79	35 Br bromine 80	36 Kr krypton 84	37 Rb rubidium 85	38 Sr strontium 88	39 Y yttrium 89	40 Zr zirconium 91	41 Nb niobium 93	42 Mo molybdenum 96	43 Tc technetium —	44 Ru ruthenium 101	45 Rh rhodium 103	46 Pd palladium 106	47 Ag silver 108	48 Cd cadmium 112	49 In indium 115	50 Sn tin 119	51 Sb antimony 122	52 Te tellurium 128	53 I iodine 127	54 Xe xenon 131	55 Cs caesium 133	56 Ba barium 137	57–71 lanthanoids	72 Hf hafnium 178	73 Ta tantalum 181	74 W tungsten 184	75 Re rhenium 186	76 Os osmium 190	77 Ir iridium 192	78 Pt platinum 195	79 Au gold 197	80 Hg mercury 201	81 Tl thallium 204	82 Pb lead 207	83 Bi bismuth 209	84 Po polonium —	85 At astatine —	86 Rn radon —	87 Fr francium —	88 Ra radium —	89–103 actinoids	104 Rf rutherfordium —	105 Db dubnium —	106 Sg seaborgium —	107 Bh bohrium —	108 Hs hassium —	109 Mt meitnerium —	110 Ds darmstadtium —	111 Rg roentgenium —	112 Cn copernicium —	114 Fl flerovium —	116 Lv livermorium —	—

57 La lanthanum 139	58 Ce cerium 140	59 Pr praseodymium 141	60 Nd neodymium 144	61 Pm promethium —	62 Sm samarium 150	63 Eu europium 152	64 Gd gadolinium 157	65 Tb terbium 159	66 Dy dysprosium 163	67 Ho holmium 165	68 Er erbium 167	69 Tm thulium 169	70 Yb ytterbium 173	71 Lu lutetium 175
89 Ac actinium —	90 Th thorium 232	91 Pa protactinium 231	92 U uranium 238	93 Np neptunium —	94 Pu plutonium —	95 Am americium —	96 Cm curium —	97 Bk berkelium —	98 Cf californium —	99 Es einsteinium —	100 Fm fermium —	101 Md mendelevium —	102 No nobelium —	103 Lr lawrencium —

The volume of one mole of any gas is 24 dm³ at room temperature and pressure (r.t.p.).