

Surname	Centre Number	Candidate Number
Other Names		2



## GCE AS/A level

1322/01

## PHYSICS – PH2

Waves and Particles

P.M. WEDNESDAY, 22 January 2014

1 hour 30 minutes

For Examiner's use only		
Question	Maximum Mark	Mark Awarded
1.	7	
2.	8	
3.	12	
4.	11	
5.	9	
6.	12	
7.	11	
8.	10	
<b>Total</b>	<b>80</b>	

### ADDITIONAL MATERIALS

In addition to this paper, you will require a calculator and a **Data Booklet**.

### INSTRUCTIONS TO CANDIDATES

Use black ink or black ball-point pen.

Write your name, centre number and candidate number in the spaces at the top of this page.

Answer **all** questions.

Write your answers in the spaces provided in this booklet.

### INFORMATION FOR CANDIDATES

The total number of marks available for this paper is 80.

The number of marks is given in brackets at the end of each question or part question.

You are reminded of the necessity for good English and orderly presentation in your answers.

You are reminded to show all working. Credit is given for correct working even when the final answer given is incorrect.

**Answer all questions.**

1. A string carrying a progressive transverse wave is photographed against a background of lines spaced 0.050 m apart. The diagrams below are based on two photographs, taken at  $t = 0$  and  $t = 0.10$  s. The wave is moving from left to right.

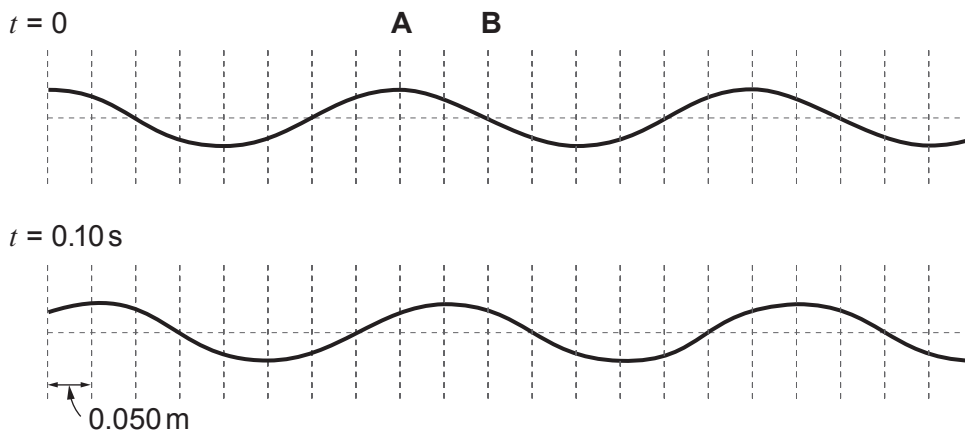

(a) Write down the wavelength of the waves. .... [1]

(b) Calculate the speed of the waves, giving your working and stating any assumption you are making. [2]

.....

.....

.....

.....

(c) Calculate the frequency of the waves. [1]

.....

.....

.....

(d) Compare the amplitude of the wave at positions A and B along the string. [1]

.....

.....

.....

(e) Compare the phases of the wave at A and B. [2]

.....

.....



**BLANK PAGE**

2. (a) Sound waves are longitudinal. Explain what this means.

[1]

Examiner  
only

- (b) Two students, Alun and Bryn, investigate the spreading of sound waves passing through a gap of width 0.30 m.

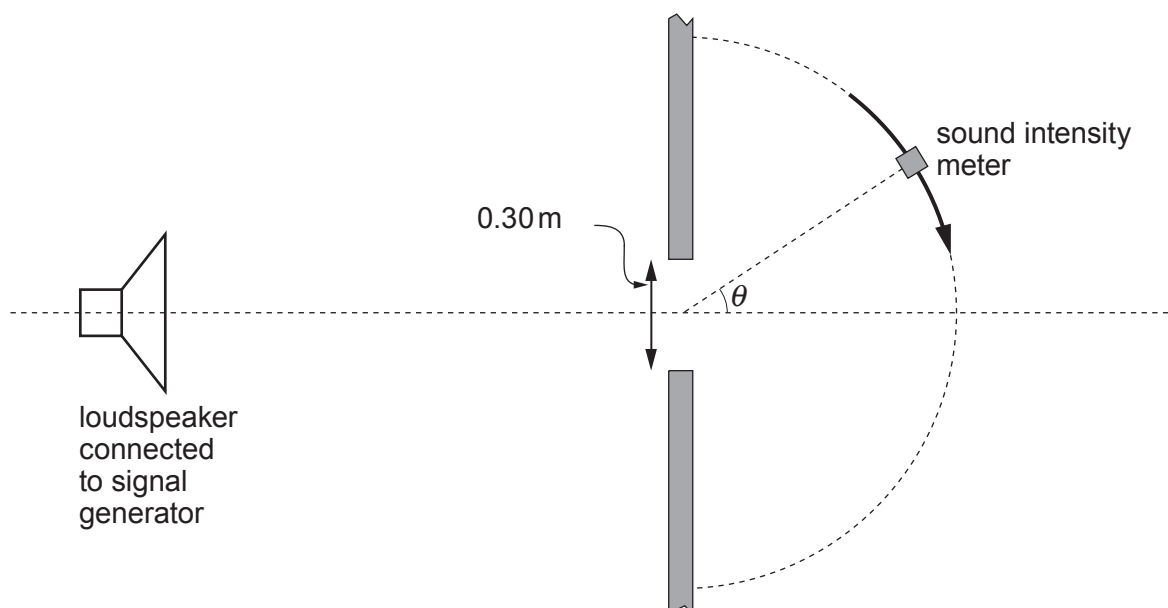

- (i) What name is given to this spreading effect of waves?

[1]

- (ii) Alun moves a sound-intensity meter around the semicircular path shown opposite, taking readings at various angles,  $\theta$ . The graph below shows the results.

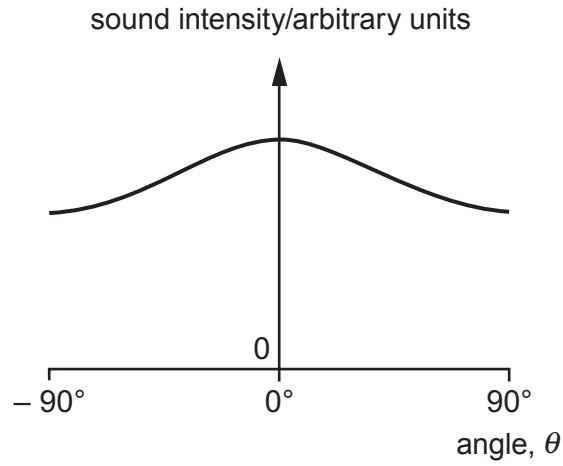

The frequency of the sound is read from the scale of the signal generator. Alun reads it as 375 Hz, and Bryn, as 3750 Hz. **Explain** which of these frequencies is more likely to be the right one. [Speed of sound in air =  $340 \text{ m s}^{-1}$ ] [3]

.....

.....

.....

.....

.....

.....

- (c) In another experiment, the students place a board in front of the loudspeaker.

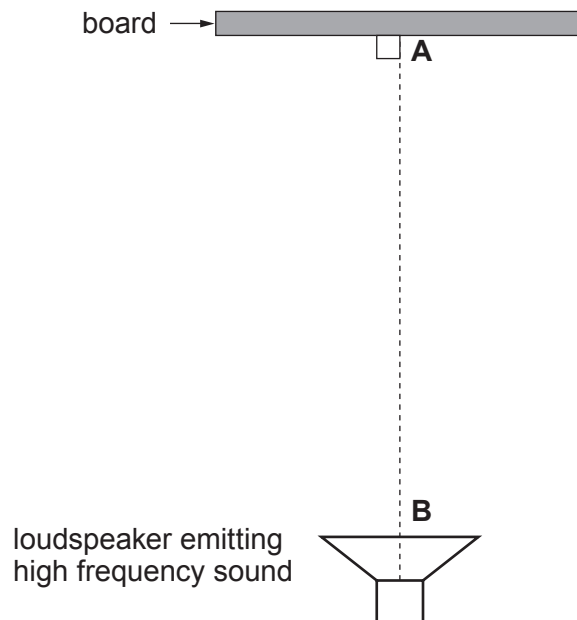

As they move the sensor for the sound intensity meter along the line **AB**, they find a pattern of alternating maxima and minima. The separation between a **maximum** and the neighbouring **minimum** is 35 mm.

Explain how the pattern arises, giving the wavelength of the sound waves.

[3]

.....

.....

.....

.....

.....

.....

3. (a)  $S_1$  and  $S_2$  are two wave sources, oscillating in phase.

(i) State what is meant by 'oscillating in phase'. [1]

.....

.....

(ii) For constructive interference at some point,  $P$ , of the waves from  $S_1$  and  $S_2$  the *path difference* = 0 or  $\lambda$  or  $2\lambda$  or  $3\lambda$  ... .



State clearly what is meant by *path difference*, adding to the diagram if it will help your explanation. [1]

.....

.....

.....

- (iii) In the set-up shown below, the in-phase sources,  $S_1$  and  $S_2$ , are emitting, in all directions, microwaves of wavelength 12 mm.

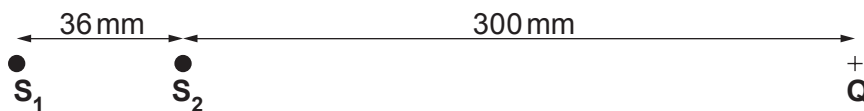

- (I) Determine whether there is constructive or destructive interference at  $Q$ , giving your reasoning. [2]

.....

.....

.....

- (II) Discuss whether or not the observed signal strength would vary if a microwave detector were moved to the right, from point  $Q$ . [2]

.....

.....

.....

- (iv) The same microwaves sources are now arranged as shown, and the detector is moved along the line  $AB$ .

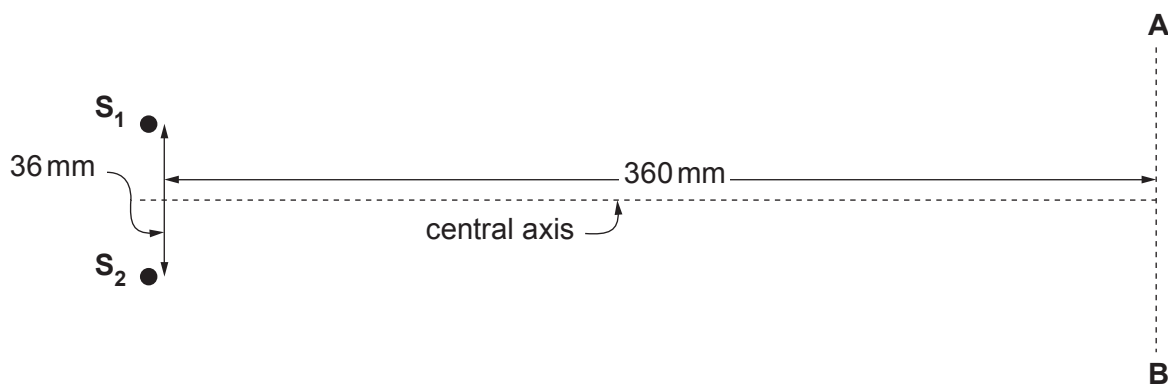

- Use the equation for double slit interference to determine the approximate spacing between points of maximum microwave intensity. [2]

.....

.....

.....



- (b) An 'array' of regularly-spaced, in-phase wave sources produces an interference pattern similar to that of a diffraction grating, that is sharply-defined beams (maxima) of waves at specific angles to the normal.

In the array shown the sources emit waves of wavelength 12 mm.

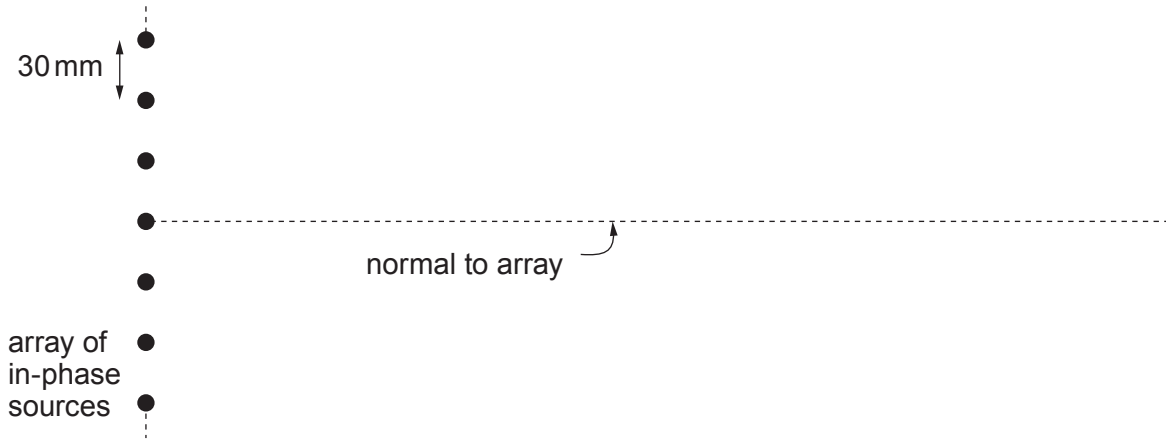

Find all the angles to the normal at which beams (maxima) occur.

[4]

.....

.....

.....

.....

.....

.....

.....

.....

1322  
0100/09

Examiner only

4. (a) Light approaches a medium of refractive index,  $n_2$  from a medium of **greater** refractive index,  $n_1$ .



- (i) **Add to the diagram** to show what is meant by the critical angle,  $c$ . [1]
- (ii) Show, in clear steps, that:  $\sin c = \frac{n_2}{n_1}$  [2]

.....

.....

.....

- (b) The diagram shows light travelling in the core of a multimode fibre at the greatest angle to the axis so no light can escape into the cladding.

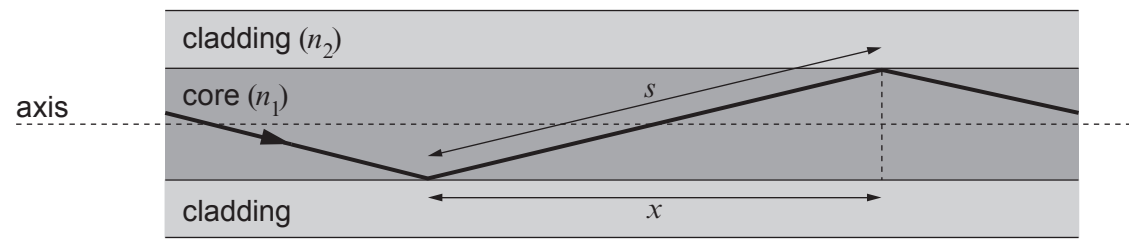

- (i) Making use of the equation from (a)(ii), and marking angle  $c$  on the diagram, show clearly that: [2]

$$s = \frac{n_1}{n_2} x$$

.....

.....

.....

- (ii) Calculate the time taken for a pulse of light to travel 1.2 km through the core in a **straight** path parallel to the axis. [Refractive index,  $n_1$ , of core = 1.500] [2]

.....

.....

.....

.....

Examiner  
only

- (iii) Calculate the **extra** time taken for the pulse to travel through the 1.2 km of core via the zig-zag path shown in the diagram. Make use of the equation:

$$s = \frac{n_1}{n_2} x$$

[Refractive index,  $n_2$ , of cladding = 1.485] [2]

.....

.....

.....

.....

.....

- (iv) Hence calculate an upper limit to the number of pulses per second that could be sent through 1.2 km of the fibre without overlap occurring. State **one** assumption you are making. [2]

.....

.....

.....

.....

.....

5. The work function of calcium is  $4.60 \times 10^{-19}$  J.

(a) (i) State what is meant by the work function of a metal. [1]

.....

.....

(ii) Calculate the lowest frequency of radiation for which Einstein's photoelectric equation applies to a calcium surface. [1]

.....

.....

.....

(iii) Explain, in physical terms, why the equation does not apply for frequencies lower than this. [2]

.....

.....

.....

(b) Calculate the frequency of radiation needed to eject electrons of maximum kinetic energy  $2.30 \times 10^{-19}$  J from the calcium surface. [2]

.....

.....

.....

.....

(c) A mercury vapour lamp emits ultraviolet radiation of frequencies  $8.2 \times 10^{14}$  Hz and  $11.8 \times 10^{14}$  Hz.

(i) Calculate the **maximum** kinetic energy of electrons ejected from a calcium surface when the lamp is placed near the surface. Explain your reasoning. [2]

.....

.....

.....

.....

- (ii) Calculate the potential difference needed to stop electrons reaching the collector electrode in the circuit shown. [1]

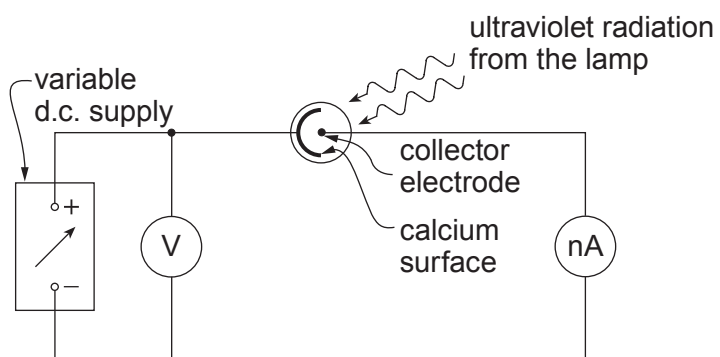
Examiner  
only

.....

.....

.....

Examiner  
only

6. (a) A simplified energy level diagram is given for a four level laser system.

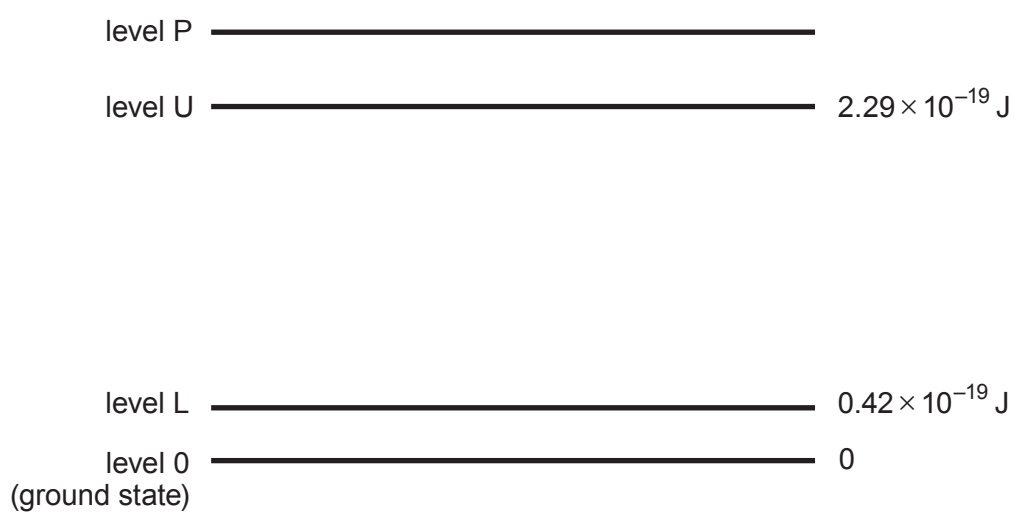

(i) Calculate the wavelength of photons involved in transitions between levels U and L. [2]

.....

.....

.....

(ii) Photons of this wavelength, present in the laser cavity, may be absorbed. Explain what this means, adding an arrow to the diagram to assist your explanation. [2]

.....

.....

.....

(iii) In a laser the probability of a photon producing stimulated emission must be greater than the probability of it being absorbed.

(i) Explain what is meant by stimulated emission, referring to levels U and L. [3]

.....

.....

.....

.....

.....

Examiner  
only

(II) Referring to all four levels, explain how the greater probability of stimulated emission over absorption is achieved in a four level laser system. [3]

.....

.....

.....

.....

.....

(b) Light from a laser is coherent. Explain what this means. [2]

.....

.....

.....

Examiner only

7. Delta Cephei is a variable star, whose surface temperature varies between fixed maximum and minimum values. Its continuous spectrum is given below for the maximum temperature and minimum temperature.

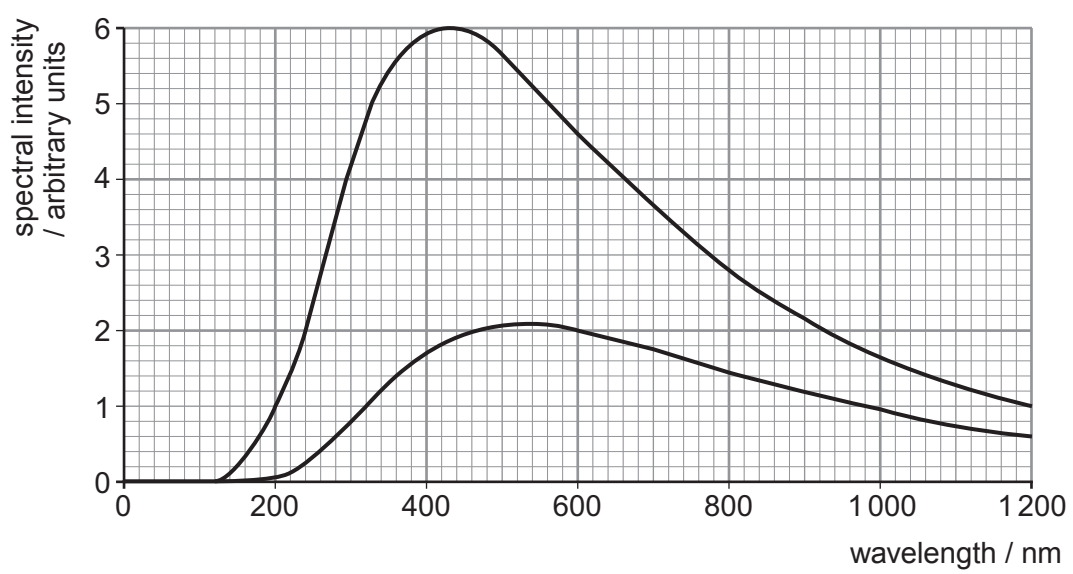

- (a) (i) Show that the star's maximum temperature is approximately 7 000 K. [2]

.....

.....

.....

- (ii) Calculate the star's minimum temperature. [1]

.....

.....

.....

- (iii) State the difference you would expect to see in the star's colour at the maximum and minimum temperatures. [1]

.....

.....



- (b) The star's luminosity (total power emitted as e-m radiation) at its maximum temperature is  $1.46 \times 10^{30}$  W. Calculate its diameter. [4]

Examiner  
only

.....

.....

.....

.....

.....

.....

.....

- (c) Calculate the **percentage** decrease in the star's luminosity as its temperature goes from maximum to minimum. [Assume its diameter does not change.] [3]

.....

.....

.....

.....

.....

.....

**TURN OVER FOR QUESTION 8**

8. (a) The particles in the table below are either first generation leptons or combinations of first generation quarks (and/or antiquarks). Complete the table. [3]

Symbol	Quark make-up (leave blank if no quarks)	Charge / e	Lepton number
p	uud	+1	0
$\Delta^{++}$	uuu		
$\pi^{-}$			
$\nu_e$			

- (b) A sequence of interactions is given.

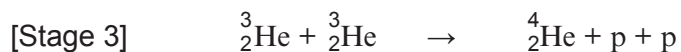
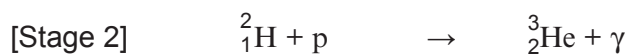

- (i) Where do these interactions take place naturally? ..... [1]

- (ii) Stage 2 takes place by means of the strong force, but another force is also involved. Identify this force, giving a reason for your answer. [1]

.....  
 .....

- (iii) Explain briefly how lepton conservation applies in **each** stage. [2]

.....  
 .....

- (iv) u and d are the two flavours of first generation quarks.

- (I) Show clearly that there is a change in quark flavour in stage 1. [2]

.....  
 .....

- (II) Explain in terms of the interactions involved why you would not expect a change in quark flavour in stage 2 or stage 3. [1]

.....  
 .....

**END OF PAPER**

**BLANK PAGE**