



UNIVERSITY OF CAMBRIDGE INTERNATIONAL EXAMINATIONS
 General Certificate of Education
 Advanced Subsidiary Level and Advanced Level

PHYSICS

9702/13

Paper 1 Multiple Choice

October/November 2011

1 hour

Additional Materials: Multiple Choice Answer Sheet
 Soft clean eraser
 Soft pencil (type B or HB is recommended)



READ THESE INSTRUCTIONS FIRST

Write in soft pencil.

Do not use staples, paper clips, highlighters, glue or correction fluid.

Write your name, Centre number and candidate number on the Answer Sheet in the spaces provided unless this has been done for you.

There are **forty** questions on this paper. Answer **all** questions. For each question there are four possible answers **A, B, C** and **D**.

Choose the **one** you consider correct and record your choice in **soft pencil** on the separate Answer Sheet.

Read the instructions on the Answer Sheet very carefully.

Each correct answer will score one mark. A mark will not be deducted for a wrong answer.

Any working should be done in this booklet.

This document consists of **28** printed pages.



2

Data

speed of light in free space,	$c = 3.00 \times 10^8 \text{ m s}^{-1}$
permeability of free space,	$\mu_0 = 4\pi \times 10^{-7} \text{ H m}^{-1}$
permittivity of free space,	$\epsilon_0 = 8.85 \times 10^{-12} \text{ F m}^{-1}$
elementary charge,	$e = 1.60 \times 10^{-19} \text{ C}$
the Planck constant,	$h = 6.63 \times 10^{-34} \text{ J s}$
unified atomic mass constant,	$u = 1.66 \times 10^{-27} \text{ kg}$
rest mass of electron,	$m_e = 9.11 \times 10^{-31} \text{ kg}$
rest mass of proton,	$m_p = 1.67 \times 10^{-27} \text{ kg}$
molar gas constant,	$R = 8.31 \text{ J K}^{-1} \text{ mol}^{-1}$
the Avogadro constant,	$N_A = 6.02 \times 10^{23} \text{ mol}^{-1}$
the Boltzmann constant,	$k = 1.38 \times 10^{-23} \text{ J K}^{-1}$
gravitational constant,	$G = 6.67 \times 10^{-11} \text{ N m}^2 \text{ kg}^{-2}$
acceleration of free fall,	$g = 9.81 \text{ m s}^{-2}$

Formulae

uniformly accelerated motion,

$$s = ut + \frac{1}{2}at^2$$

$$v^2 = u^2 + 2as$$

work done on/by a gas,

$$W = p\Delta V$$

gravitational potential,

$$\phi = -\frac{Gm}{r}$$

hydrostatic pressure,

$$p = \rho gh$$

pressure of an ideal gas,

$$p = \frac{1}{3} \frac{Nm}{V} \langle c^2 \rangle$$

simple harmonic motion,

$$a = -\omega^2 x$$

velocity of particle in s.h.m.,

$$v = v_0 \cos \omega t$$

$$v = \pm \omega \sqrt{x_0^2 - x^2}$$

electric potential,

$$V = \frac{Q}{4\pi\epsilon_0 r}$$

capacitors in series,

$$1/C = 1/C_1 + 1/C_2 + \dots$$

capacitors in parallel,

$$C = C_1 + C_2 + \dots$$

energy of charged capacitor,

$$W = \frac{1}{2}QV$$

resistors in series,

$$R = R_1 + R_2 + \dots$$

resistors in parallel,

$$1/R = 1/R_1 + 1/R_2 + \dots$$

alternating current/voltage,

$$x = x_0 \sin \omega t$$

radioactive decay,

$$x = x_0 \exp(-\lambda t)$$

decay constant,

$$\lambda = \frac{0.693}{t_{\frac{1}{2}}}$$

4

- 1 Which group of quantities contains only vectors?
- A acceleration, displacement, speed
 - B acceleration, work, electric field strength
 - C displacement, force, velocity
 - D power, electric field strength, force
- 2 Which statement using prefixes of the base unit metre (m) is **not** correct?
- A $1 \text{ pm} = 10^{12} \text{ m}$
 - B $1 \text{ nm} = 10^9 \text{ m}$
 - C $1 \text{ Mm} = 10^6 \text{ m}$
 - D $1 \text{ Gm} = 10^{12} \text{ m}$

Space for working

5

- 3 The Young modulus of the material of a wire is to be found. The Young modulus E is given by the equation below.

$$E = \frac{4Fl}{\pi d^2 x}$$

The wire is extended by a known force and the following measurements are made.

Which measurement has the largest effect on the uncertainty in the value of the calculated Young modulus?

	measurement	symbol	value
A	length of wire before force applied	l	2.043 ± 0.002 m
B	diameter of wire	d	0.54 ± 0.02 mm
C	force applied	F	19.62 ± 0.01 N
D	extension of wire with force applied	x	5.2 ± 0.2 mm

- 4 An Olympic athlete of mass 80 kg competes in a 100 m race.

What is the best estimate of his mean kinetic energy during the race?

- A** 4×10^2 J **B** 4×10^3 J **C** 4×10^4 J **D** 4×10^5 J

Space for working

6

- 5 A cylindrical tube rolling down a slope of inclination θ moves a distance L in time T . The equation relating these quantities is

$$L \left(3 + \frac{a^2}{P} \right) = QT^2 \sin \theta$$

Where a is the internal radius of the tube and P and Q are constants.

Which line gives the correct units for P and Q ?

	P	Q
A	m^2	$\text{m}^2 \text{s}^2$
B	m^2	m s^2
C	m^2	$\text{m}^3 \text{s}^2$
D	m^3	ms^2

Space for working

7

- 6 A tennis ball is released from rest at the top of a tall building.

Which graph best represents the variation with time t of the acceleration a of the ball as it falls, assuming that the effect of air resistance is **not** negligible?

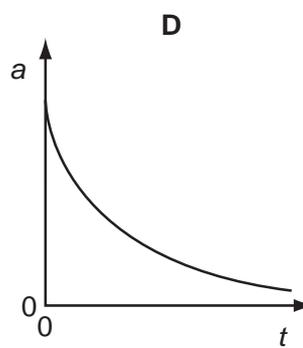
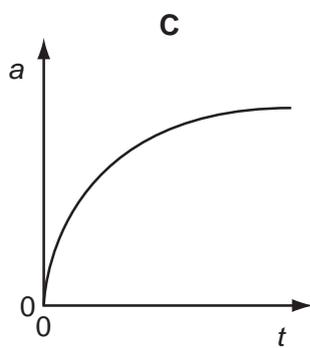
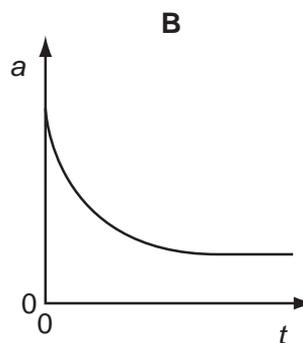
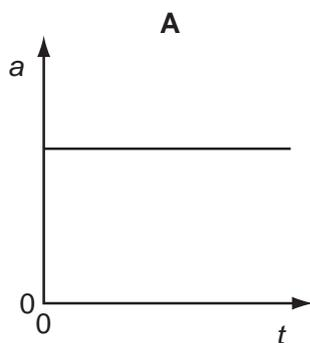

Space for working

8

7 A ball is released from rest on a smooth slope XY.

It moves down the slope, along a smooth horizontal surface YZ and rebounds inelastically at Z. Then it moves back to Y and comes to rest momentarily somewhere on XY.

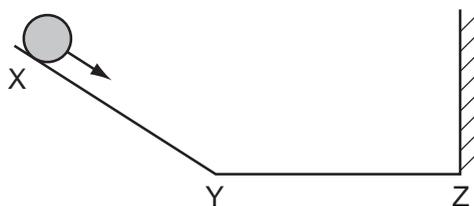

Which velocity-time graph represents the motion of the ball?

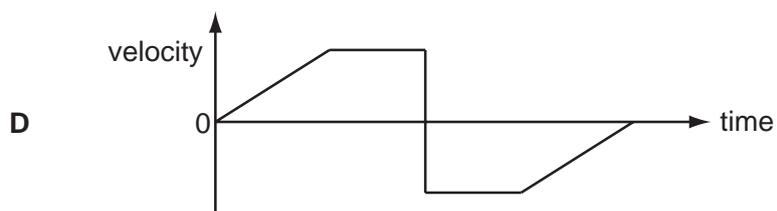
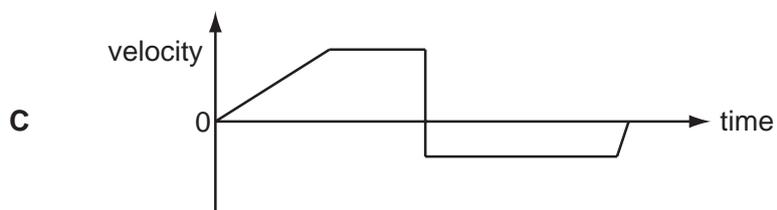
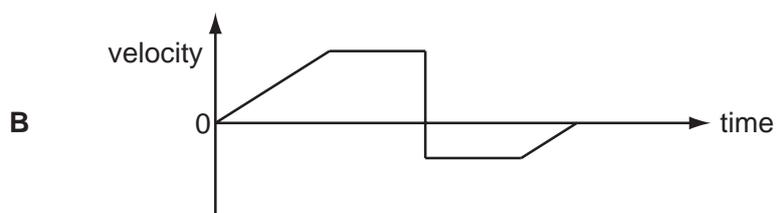
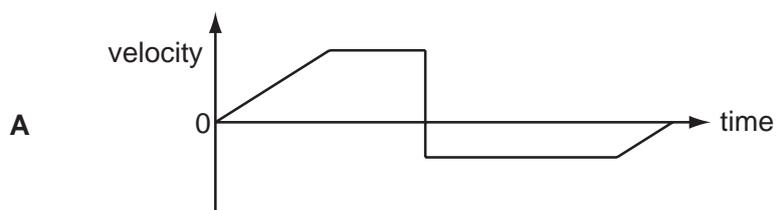

Space for working

- 8 A body falling in a uniform gravitational field encounters air resistance. The air resistance increases until terminal velocity is reached.

Which factor does **not** affect its terminal velocity?

- A the density of the air
 B the height from which the body falls
 C the mass of the body
 D the shape of the body
- 9 A boy throws a ball vertically upwards. It rises to a maximum height, where it is momentarily at rest, and then falls back to his hands.

Which row gives the acceleration of the ball at various stages in its motion? (Take vertically upwards as positive. Ignore air resistance.)

	rising	at maximum height	falling
A	-9.81 ms^{-2}	0	$+9.81 \text{ ms}^{-2}$
B	-9.81 ms^{-2}	-9.81 ms^{-2}	-9.81 ms^{-2}
C	$+9.81 \text{ ms}^{-2}$	$+9.81 \text{ ms}^{-2}$	$+9.81 \text{ ms}^{-2}$
D	$+9.81 \text{ ms}^{-2}$	0	-9.81 ms^{-2}

Space for working

- 10 An ice-hockey puck slides along a horizontal, frictionless ice-rink surface. It collides inelastically with a wall at right angles to its path, and then rebounds along its original path.

Which graph shows the variation with time t of the momentum p of the puck?

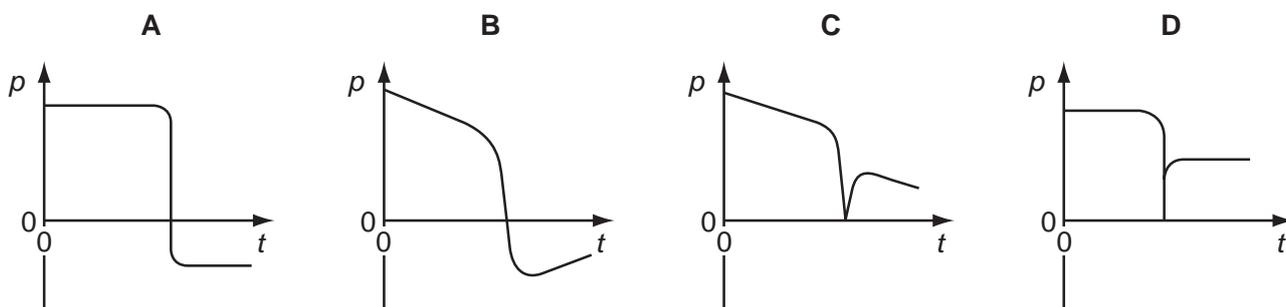

- 11 What is the **definition** of the force on a body?

- A the mass of the body multiplied by its acceleration
- B the power input to the body divided by its velocity
- C the rate of change of momentum of the body
- D the work done on the body divided by its displacement

Space for working

- 12 A car accelerates from rest. The graph shows the momentum of the car plotted against time.

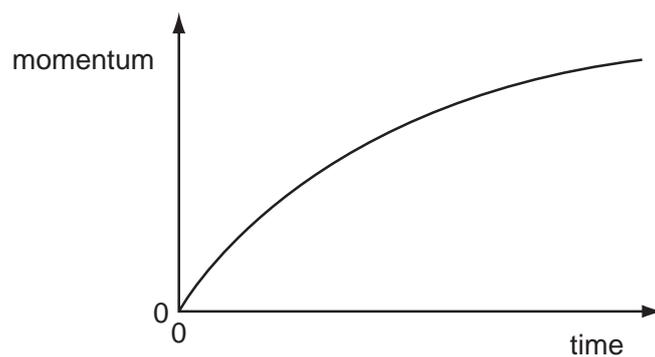

What is the meaning of the gradient of the graph at a particular time?

- A the resultant force on the car
 - B the velocity of the car
 - C the kinetic energy of the car
 - D the rate of change of kinetic energy of the car
- 13 The diagram shows a child's balancing game.

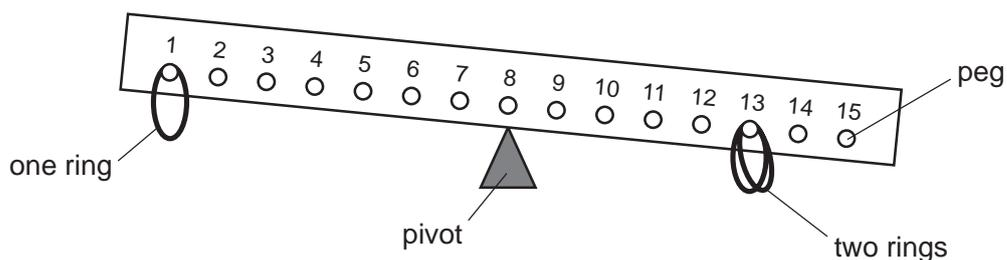

The wooden rod is uniform and all the rings are of equal mass. Two rings are hung on peg 13 and one on peg 1.

On which hook must a fourth ring be hung in order to balance the rod?

- A 2
- B 3
- C 5
- D 6

Space for working

14 A ladder rests in equilibrium on rough ground against a rough wall.



Its weight W acts through the centre of gravity G . Forces also act on the ladder at P and at Q . These forces are P and Q respectively.

Which vector triangle represents the forces on the ladder?

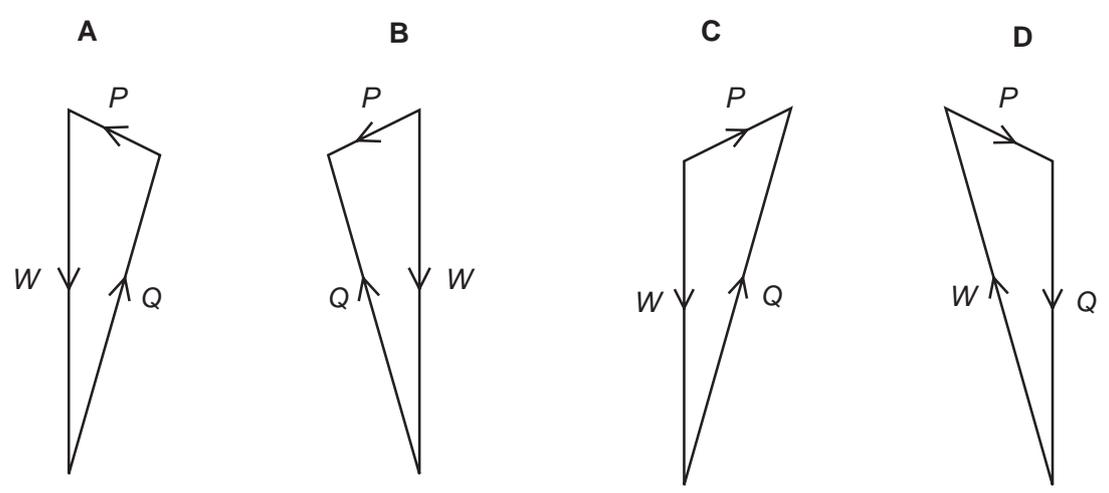

Space for working

- 15 A ruler of length 0.30 m is pivoted at its centre. Equal and opposite forces of magnitude 2.0 N are applied to the ends of the ruler, creating a couple as shown.

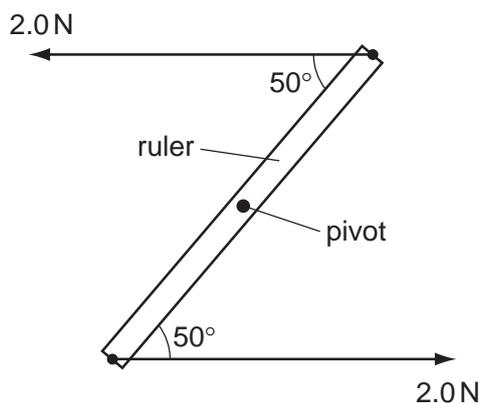

What is the magnitude of the torque of the couple on the ruler when it is in the position shown?

- A 0.23 N m B 0.39 N m C 0.46 N m D 0.60 N m
- 16 The first column in the table gives four examples of work being done. The second column gives more detail of the action.

Which row is **not** correct?

	example	detail
A	a girl dives from a diving board into a swimming pool	work is done by the girl against gravity as she falls
B	a man pushes a car along a level road	work is done by the man against friction
C	an electron is accelerated towards a positively-charged plate	work is done on the electron by the electric field of the plate
D	a piston is pushed outwards as a gas expands	work is done on the atmosphere by the gas

Space for working

- 17 The diagram shows a particle X, with kinetic energy E_k , about to collide with a stationary particle Y. Both particles have the same mass.



After colliding, X and Y travel onwards together as a single larger particle.

How much kinetic energy is lost in the collision?

- A 0 B $\frac{E_k}{4}$ C $\frac{E_k}{2}$ D $\frac{3E_k}{4}$
- 18 An electric motor is required to produce 120 W of mechanical output power. The efficiency of the motor is 80 %.

Which row is correct?

	electrical power input to motor/W	waste heat output from motor/W
A	120	24
B	120	96
C	150	30
D	150	120

Space for working

- 19 A mass m is situated in space in a uniform gravitational field.

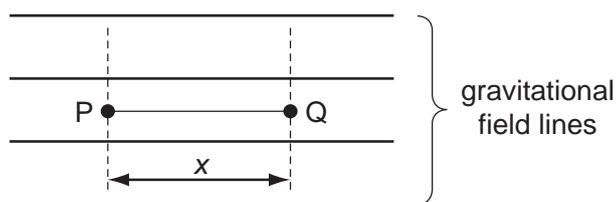

When the mass moves through a displacement x , from P to Q, it loses an amount of potential energy E .

Which row correctly specifies the magnitude and the direction of the acceleration due to the gravity in this field?

	magnitude	direction
A	$\frac{E}{mx}$	\rightarrow
B	$\frac{E}{mx}$	\leftarrow
C	$\frac{E}{x}$	\rightarrow
D	$\frac{E}{x}$	\leftarrow

Space for working

- 20 A trolley runs from P to Q along a track. At Q its potential energy is 50 kJ less than at P.

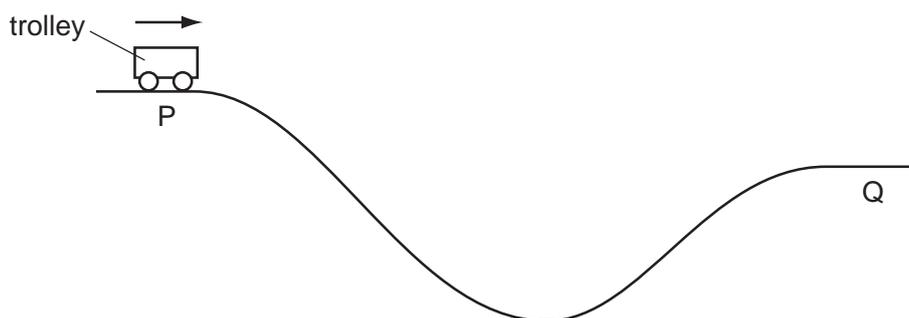

At P, the kinetic energy of the trolley is 5 kJ. Between P and Q, the work the trolley does against friction is 10 kJ.

What is the kinetic energy of the trolley at Q?

- A 35 kJ B 45 kJ C 55 kJ D 65 kJ
- 21 The Young modulus of steel is determined using a length of steel wire and is found to have the value E .

Another experiment is carried out using a wire of the same steel, but of half the length and half the diameter.

What value is obtained for the Young modulus in the second experiment?

- A $\frac{1}{2}E$ B E C $2E$ D $4E$

Space for working

- 22 A rubber band is stretched and then relaxed to its original length. The diagram shows the force-extension graph for this process.

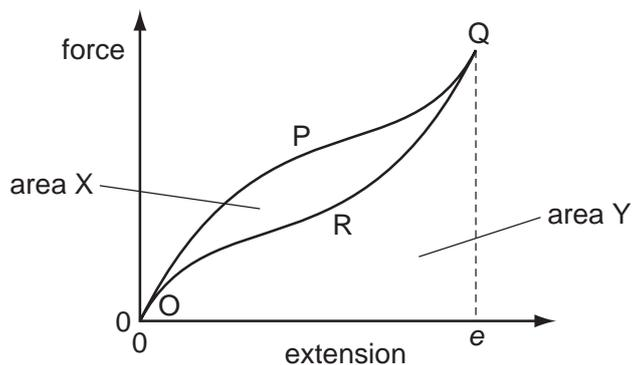

As the force is increased, the curve follows the path OPQ to extension e . As the force is reduced, the curve follows the path QRO to return to zero extension.

The area labelled X is between the curves OPQ and QRO. The area labelled Y is bounded by the curve QRO and the horizontal axis.

Which statement about the process is correct?

- A Area X is the energy which heats the band as it is stretched to e .
- B (Area X + area Y) is the minimum energy required to stretch the band to e .
- C Area X is the elastic potential energy stored in the band when it is stretched to e .
- D (Area Y – area X) is the net work done on the band during the process.

Space for working

- 23 Pollen grains are suspended in a liquid and are illuminated strongly. When observed under a microscope they are seen to be in continuous random motion.

What is the reason for this?

- A convection currents in the liquid
 - B evaporation of the liquid
 - C molecules of the liquid colliding with the pollen grains
 - D pollen grains colliding with each other
- 24 Why does the pressure increase when a sealed container of gas is heated?
- A The gas molecules collide more often with each other.
 - B The gas molecules expand when they are heated.
 - C The gas molecules travel faster and hit the walls of the container more often.
 - D There are more gas molecules present to collide with the walls of the container.
- 25 A metal cube of side l is placed in a vice and compressed elastically by two opposing forces F .

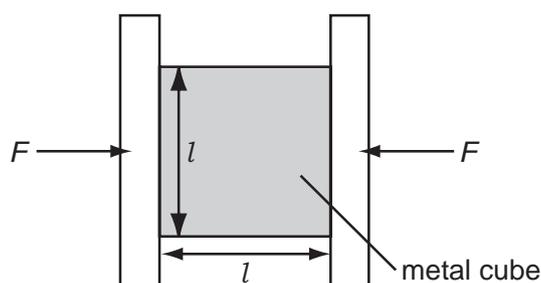

How will Δl , the amount of compression, relate to l ?

- A $\Delta l \propto \frac{1}{l^2}$
- B $\Delta l \propto \frac{1}{l}$
- C $\Delta l \propto l$
- D $\Delta l \propto l^2$

Space for working

26 When describing the behaviour of a spring, the spring constant is used.

Different loads are used to extend the spring by different amounts.

To find the spring constant, which quantities are required?

- A the elastic limit and the loads
- B the elastic limit, extensions and the length of the spring
- C the loads and the extensions of the spring
- D the loads and the length of the spring

27 The diagram shows a view from above of a double slit interference demonstration.

L is a monochromatic light source with a vertical filament. B is a barrier with two narrow vertical slits and S is a screen upon which interference fringes form.

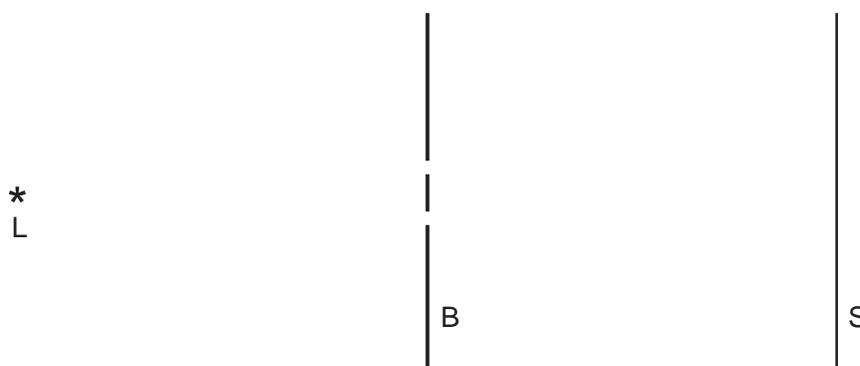

The intensity is I at a point on the screen where the centre of the fringe pattern forms.

What is the intensity, at the same point, when one of the slits is covered up?

- A $\frac{I}{\sqrt{2}}$
- B $\frac{I}{2}$
- C $\frac{I}{2\sqrt{2}}$
- D $\frac{I}{4}$

Space for working

- 28 P is a source emitting infra-red radiation and Q is a source emitting ultra-violet radiation. The figures in the table are suggested values for the wavelengths emitted by P and Q.

Which row is correct?

	wavelength emitted by P/m	wavelength emitted by Q/m
A	5×10^5	5×10^8
B	5×10^5	5×10^{10}
C	5×10^7	5×10^8
D	5×10^7	5×10^{10}

- 29 Coherent waves are produced at P and at Q and travel outwards in all directions. The line RS is halfway between P and Q and perpendicular to the line joining P and Q. The distance RS is much greater than the distance PQ.

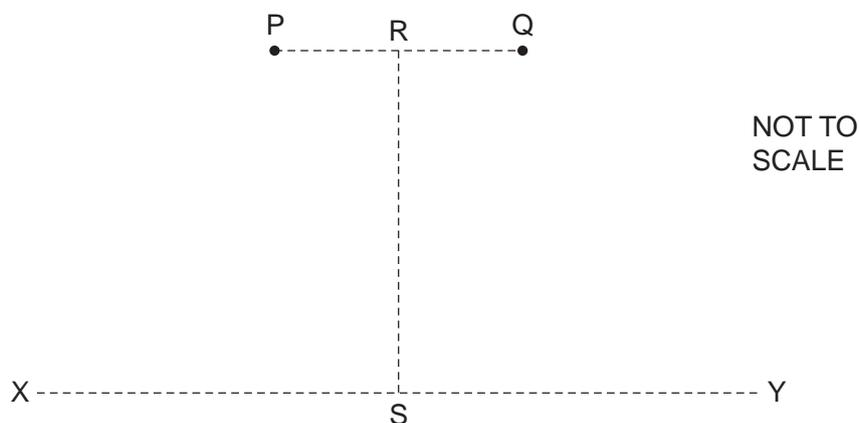

Along which line, or lines, is an interference pattern observed?

- A** both RS and XY
- B** RS only
- C** XY only
- D** neither RS nor XY

Space for working

- 30 Travelling waves of wavelength 20 cm are created in the air columns in a closed pipe P and an open pipe Q. The lengths of the pipes are shown.

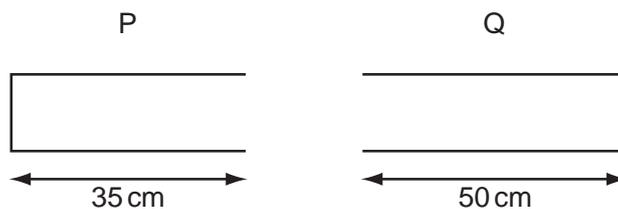

In which pipe or pipes are stationary waves formed?

- A P and Q
 B P only
 C Q only
 D neither P nor Q
- 31 The diagram shows an insulating rod with equal and opposite point charges at each end. An electric field of strength E acts on the rod in a downwards direction.

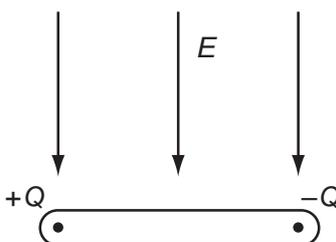

Which row is correct?

	resultant force	resultant torque
A	zero	clockwise
B	downwards	clockwise
C	zero	anti-clockwise
D	downwards	anti-clockwise

Space for working

- 32 Two horizontal parallel plate conductors are separated by a distance of 5.0 mm in air. The lower plate is earthed and the potential of the upper plate is +50 V.

What is the electric field strength E at a point midway between the plates?

- A $1.0 \times 10^4 \text{ V m}^{-1}$ downwards
B $1.0 \times 10^4 \text{ V m}^{-1}$ upwards
C $2.0 \times 10^4 \text{ V m}^{-1}$ downwards
D $2.0 \times 10^4 \text{ V m}^{-1}$ upwards
- 33 An atomic nucleus emits a β -particle.

What change does this cause to the proton number and the nucleon number of the nucleus?

	proton number	nucleon number
A	-1	+1
B	0	-1
C	+1	-1
D	+1	0

Space for working

- 34 Which statement is **not** valid?
- A Current is the speed of the charged particles that carry it.
 - B Electromotive force (e.m.f.) is the energy converted to electrical energy from other forms, per unit charge.
 - C The potential difference (p.d.) between two points is the work done in moving unit charge from one point to the other.
 - D The resistance between two points is the p.d. between the two points, per unit current.
- 35 Which statement about electrical resistivity is correct?
- A The resistivity of a material is numerically equal to the resistance in ohms of a cube of that material, the cube being of side length one metre and the resistance being measured between opposite faces.
 - B The resistivity of a material is numerically equal to the resistance in ohms of a one metre length of wire of that material, the area of cross-section of the wire being one square millimetre and the resistance being measured between the ends of the wire.
 - C The resistivity of a material is proportional to the cross-sectional area of the sample of the material used in the measurement.
 - D The resistivity of a material is proportional to the length of the sample of the material used in the measurement.

Space for working

- 36 A cell, two resistors of equal resistance and an ammeter are used to construct four circuits. The resistors are the only parts of the circuits that have resistance.

In which circuit will the ammeter show the greatest reading?

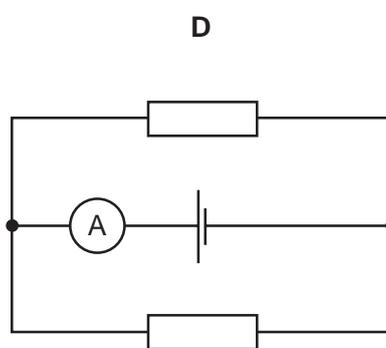
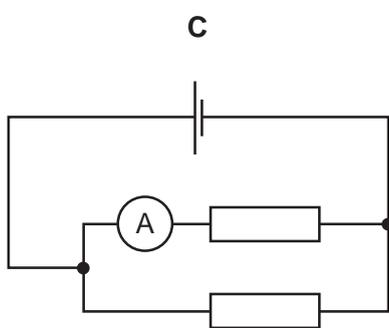
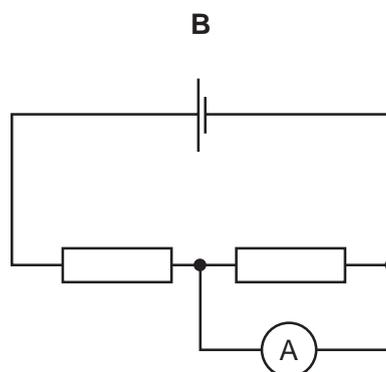
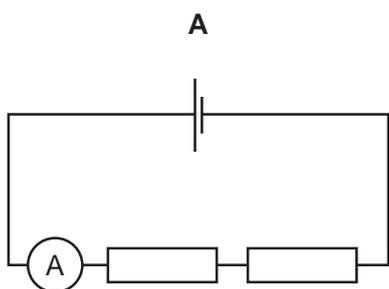

Space for working

- 37 Three resistors of resistance R , $2R$ and $3R$ are connected in parallel.

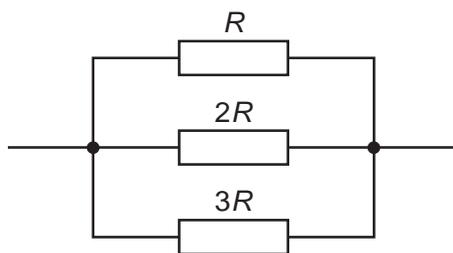

Using I to represent the current through the resistor of resistance R , which row represents the relationships between the currents through the resistors?

	resistor resistance		
	R	$2R$	$3R$
A	I	$\frac{1}{3}I$	$\frac{1}{2}I$
B	I	$\frac{1}{2}I$	$\frac{1}{3}I$
C	I	$\frac{2}{3}I$	$\frac{1}{3}I$
D	I	$2I$	$3I$

Space for working

- 38 A cell of e.m.f. E and internal resistance r is connected in series with a switch S and an external resistor of resistance R .

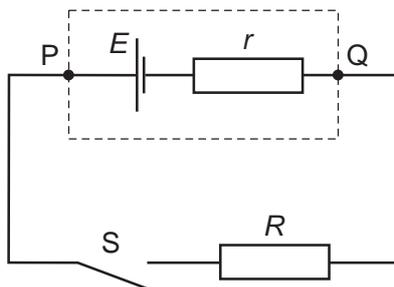

The p.d. between P and Q is V .

When S is closed,

- A V decreases because there is a p.d. across R .
- B V decreases because there is a p.d. across r .
- C V remains the same because the decrease of p.d. across r is balanced by the increase of p.d. across R .
- D V remains the same because the sum of the p.d.s across r and R is still equal to E .

Space for working

39 Which of the equations that link some of the following terms is correct?

potential difference (p.d.)	V
current	I
resistance	R
charge	Q
energy	E
power	P
time	t

A $P = \frac{Q^2 R}{t}$

B $ER^2 = V^2 t$

C $\frac{VI}{P} = t$

D $PQ = EI$

Space for working

40 The diagram shows a potential divider circuit designed to provide a variable output p.d.

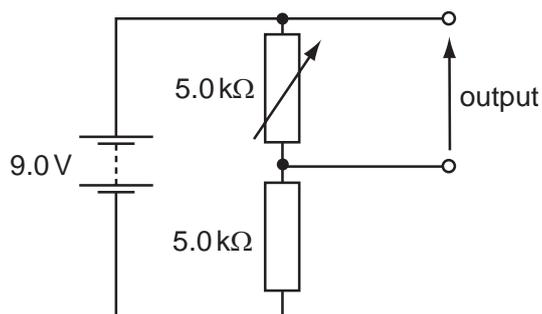

Which row gives the available range of output p.d.?

	maximum output	minimum output
A	3.0V	0
B	4.5V	0
C	9.0V	0
D	9.0V	4.5V

Space for working

Permission to reproduce items where third party owned material protected by copyright is included has been sought and cleared where possible. Every reasonable effort has been made by the publisher (UCLES) to trace copyright holders, but if any items requiring clearance have unwittingly been included, the publisher will be pleased to make amends at the earliest possible opportunity.

University of Cambridge International Examinations is part of the Cambridge Assessment Group. Cambridge Assessment is the brand name of University of Cambridge Local Examinations Syndicate (UCLES), which is itself a department of the University of Cambridge.