

Edexcel IAL Physics A-level

Topic 2.4: Electric Circuits Notes

This work by [PMT Education](https://www.pmt.education) is licensed under [CC BY-NC-ND 4.0](https://creativecommons.org/licenses/by-nc-nd/4.0/)



2.4 - Electric Circuits

2.4.64 - Electric current

Electric current (I) is the **rate of flow of charged particles**, or the flow of charge per unit time.

$$I = \frac{\Delta Q}{\Delta t}$$

Where ΔQ is the change in charge and Δt is the change in time.

2.4.65 - Potential difference

Potential difference (V) is the **energy transferred per unit charge** between two points in a circuit.

$$V = \frac{W}{Q}$$

Where W is the energy transferred and Q is the charge.

2.4.66 - Resistance

Resistance (R) is a measure of how difficult it is for charge carriers to pass through a component. It is measured by dividing the potential difference across a component by the current flowing through it.

$$R = \frac{V}{I}$$

Where V is the potential difference and I is the current.

Ohm's law states that for an **ohmic conductor**, **current is directly proportional to the potential difference** across it, given that physical conditions (e.g temperature) are kept **constant**.

2.4.67a - Charge conservation

The **principle of charge conservation** states that the **total electric charge** in a closed system does **not** change.

An application of the principle of charge conservation is Kirchoff's first law, which states:

- The total **current flowing into** a junction is **equal** to the **current flowing out** of that junction.

Therefore, due to **charge conservation**, the distribution of current in a circuit is as follows:

- In a **series** circuit -
 - The current is the **same** everywhere in the circuit.
- In a **parallel** circuit -
 - The **sum** of the currents in each parallel set of branches is **equal** to the **total current**.

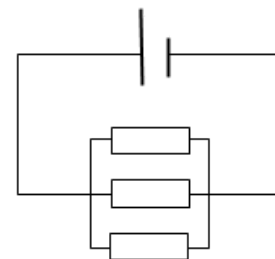
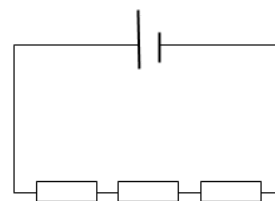



2.4.67b - Energy conservation

The **principle of conservation of energy** states that **energy cannot be created or destroyed**, but can be transferred from one form to another. Therefore, the total energy in a closed system stays constant.

An application of the principal of energy conservation and charge conservation is Kirchoff's second law, which states:

- The **sum** of all the voltages in a **series** circuit is **equal** to the **battery voltage** or the **sum** of all the voltages in a **loop** is **zero**.

Therefore, due to **energy conservation**, the distribution of potential differences in a circuit is as follows:

- In a **series** circuit -
 - The battery p.d is shared across all elements in the circuit, therefore the **total sum of the voltages** across all elements is **equal** to the **supply p.d**.
- In a **parallel** circuit -
 - The potential difference across each branch is the **same**.

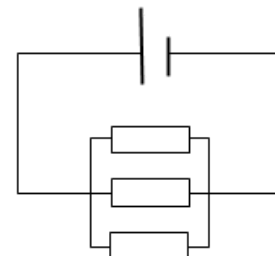
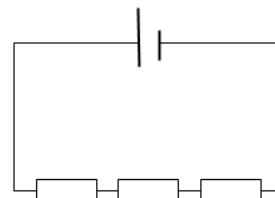

This is easy to see with the series circuit as it is a direct application of Kirchoff's second law (as described above) but takes a little more thought with the parallel circuit:

→ Consider you are taking the blue path drawn on the circuit below.

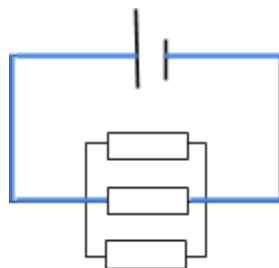

- It is a **closed loop** so Kirchoff's second law applies, and so the potential difference across the middle resistor must be equal to the supply potential difference.
- You can repeat this for each possible path in the circuit. This leads to the fact that the potential difference across each branch is the same.

2.4.68 - Combining resistances

There are two rules for adding the resistances of resistors in circuits, which are used depending on whether the resistors are in series or in parallel.

In a **series** circuit -

$$R_T = R_1 + R_2 + R_3 + \dots$$



Where R_T is total resistance and R_n is the resistance of resistor n.

In order to derive the above formula, consider a series circuit with 3 resistors, with 3 different resistances, R_1 , R_2 , R_3 .

Using **Ohm's law**, you can calculate the voltage across each resistor, as you know that the **current flowing through each resistor is the same** (Kirchoff's first law).

$$V_1 = IR_1 \quad V_2 = IR_2 \quad V_3 = IR_3$$

Next, you can apply **Kirchoff's second law**, which states that the sum of the voltages in a series circuit is equal to the supply voltage.

$$V = V_1 + V_2 + V_3$$

You can replace each of the individual potential differences, (V_1 etc.) using the equations from the first step.

$$V = IR_1 + IR_2 + IR_3$$

Finally, factor out the current (I).

$$V = I(R_1 + R_2 + R_3)$$

Notice that you have something that looks like Ohm's law, except that the value of resistance is equal to $R_1 + R_2 + R_3$, meaning that this is the **total resistance**.

This can be extended to involve n many resistors in order to derive the general formula.

In a parallel circuit -

$$\frac{1}{R_T} = \frac{1}{R_1} + \frac{1}{R_2} + \frac{1}{R_3} + \dots$$

Where R_T is total resistance and R_n is the resistance of resistor n.

In order to derive the above formula, consider a series circuit with 3 resistors, with 3 different resistances, R_1 , R_2 , R_3 .

Due to **Kirchoff's second law**, you know that the **potential difference across each resistor is the same as the supply voltage**.

Using this and **Ohm's law**, you can write 3 equations for the current across each resistor.

$$I_1 = \frac{V}{R_1} \quad I_2 = \frac{V}{R_2} \quad I_3 = \frac{V}{R_3}$$

Due to conservation of charge, the sum of these individual currents must be equal to the overall current in the circuit (I).

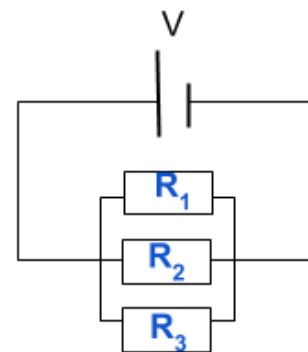
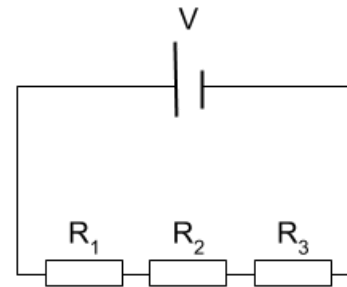

$$I = I_1 + I_2 + I_3$$

You can replace each of the individual currents, (I_1 etc.) using the equations from the first step.

$$I = \frac{V}{R_1} + \frac{V}{R_2} + \frac{V}{R_3}$$

Next, factor out the supply voltage (V) and rearrange to get the equation for Ohm's law (with V as the subject).

$$I = V \left(\frac{1}{R_1} + \frac{1}{R_2} + \frac{1}{R_3} \right)$$

$$V = I \times \frac{1}{\frac{1}{R_1} + \frac{1}{R_2} + \frac{1}{R_3}}$$

The above equation implies that:

$$R_T = \frac{1}{\frac{1}{R_1} + \frac{1}{R_2} + \frac{1}{R_3}}$$

And so by finding the reciprocal, you can see that..

$$\frac{1}{R_T} = \frac{1}{R_1} + \frac{1}{R_2} + \frac{1}{R_3}$$

This can be extended to involve n many resistors in order to derive the general formula.

You may need to use both of these rules when calculating the resistance of one circuit, for example: Find the resistance of the circuit in the diagram below.

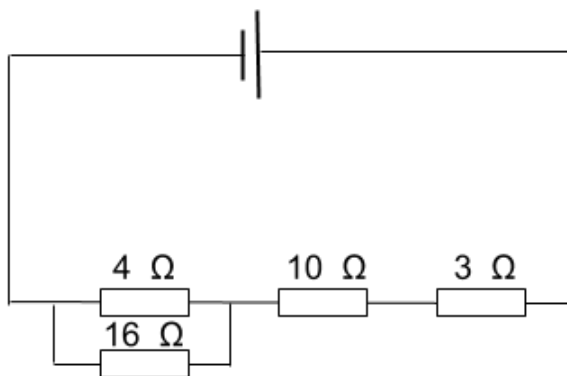

Firstly, find the resistance of the parallel combinations of resistors:

$$\frac{1}{R_T} = \frac{1}{4} + \frac{1}{16} = \frac{5}{16} \quad R_T = 3.2 \Omega$$

Then, use the series rule to add the remaining two resistors to the value calculated for the parallel combination.

$$R_T = 10 \Omega + 3 \Omega + 3.2 \Omega = 16.2 \Omega \text{ So the total resistance is } \mathbf{16.2 \Omega}.$$



2.4.69 - Equations involving power

Power (P) is the energy transferred over time or rate of transfer of energy. It can be calculated by multiplying the voltage across a component by the current flowing through it:

$$P = VI$$

Where **V** is the voltage and **I** is the current.

As power is the energy transferred per unit time, you can multiply power by time to find the **energy transferred (W)**.

$$W = Pt$$

$$W = VIt$$

Where **V** is the voltage, **I** is the current and **W** is the energy transferred.

Below is an example in which you need to use the above formulas:

A lamp has a power of 60 W, and is connected to a power source of 240 V. Find the energy transferred by the lamp in 2 minutes and the current in the lamp.

To find the energy transferred you can use the formula $W = Pt$, making sure time is converted into seconds.

$$W = 60 \times 120 = \mathbf{7200 \text{ J}}$$

To find the current, you can use the (rearranged) formula $I = \frac{P}{V}$.

$$I = \frac{60}{240} = \mathbf{0.25 \text{ A}}$$

By using the Ohm's law ($V = IR$), and the formula for power shown above ($P = VI$), you can derive two more formulas for calculating power.

$$P = VI = (IR) \times I = I^2R \quad \Rightarrow \quad P = I^2R$$

$$P = VI = V \times \frac{V}{R} = \frac{V^2}{R} \quad \Rightarrow \quad P = \frac{V^2}{R}$$

2.4.70 - Current-voltage graphs

You must be able to recognise and understand the properties of certain components as demonstrated by their current-voltage graphs:

- **Ohmic conductor** - this component **follows Ohm's law** therefore its current-voltage graph will look like a straight line through the origin. (This is provided physical conditions are kept constant).



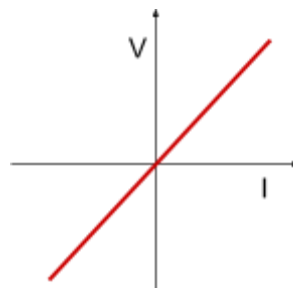
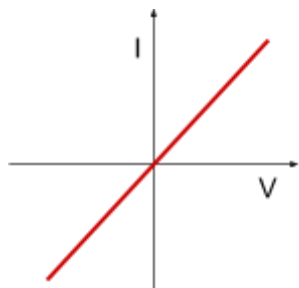

- **Semiconductor diode** - when looking at the current-voltage graph of this component you must consider its forward and reverse bias. The forward bias of a diode is the direction in which it will allow current to flow easily past the **threshold voltage**, which is the smallest voltage needed to allow current to flow. In the direction of the reverse bias, the resistance of the diode is extremely high meaning that only a very small current can flow.

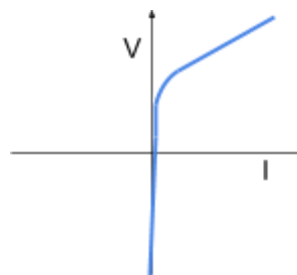
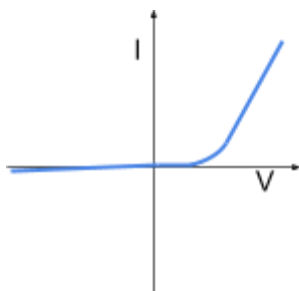

- **Filament bulb** - This component contains a length of metal wire, which **heats up as current increases**, therefore the resistance of this component increases as current increases. At low currents the metal wire will not heat up significantly, therefore for very **low currents, Ohm's law is obeyed**. However, as the current increases (in either direction), the graph begins to curve due to the increasing resistance.

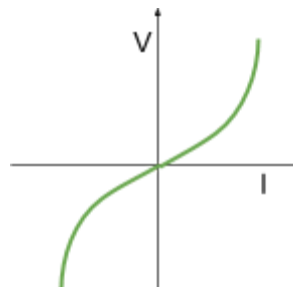
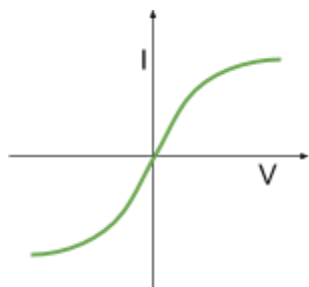

- **(Negative Temperature Coefficient) Thermistor** - This component acts in the **opposite** way to a filament bulb because as it heats up (due to an increase in current), the resistance across it will decrease. This is because increasing the temperature of a thermistor causes electrons to be emitted from atoms, therefore the number of charge carriers increases and so current increases causing resistance to decrease. Similarly to a filament bulb, at **low currents**, where temperature is kept constant, **Ohm's law is obeyed**.



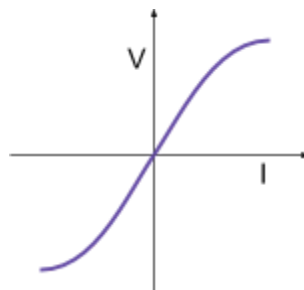
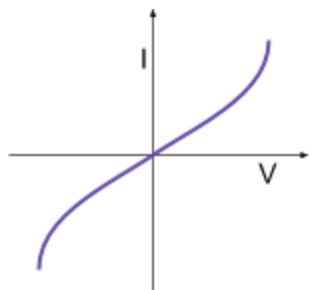

2.4.71 - Resistivity

Resistivity (ρ) is a measure of how easily a material conducts electricity, it is defined as the product of resistance and cross-sectional area, divided by the length of the material. Resistivity will give the **value of resistance through a material of length 1 m and cross-sectional area 1 m²** which is useful when you need to **compare** materials even though they may not be the same size, however resistivity is also dependent on environmental factors, such as **temperature**.

$$\rho = \frac{RA}{l}$$

Where **R** is the resistance, **A** is the cross-sectional area and **l** is the length.

You can rearrange the above equation to get a formula for the resistance of an object, given its dimensions and the resistivity of the material it is made from:

$$R = \frac{\rho l}{A}$$

Where **ρ** is the resistivity, **A** is the cross-sectional area and **l** is the length.

2.4.73 - Range of resistivities

Current (I) is the rate of flow of charged particles and so can be calculated by considering the following factors:

- The **number of charged particles** travelling across a conductor-
 - The **charge carrier density (n)** of a material describes the number of charge carriers it contains per unit volume.
- The **speed** at which the charged particles are travelling -
 - Charged particles in a conductor are **constantly colliding** with other particles in the conductor and so do **not** travel straight through a conductor, so the **average** speed at which they move along the conductor must be considered. This is called the **drift velocity (v)**.
- The **charge (q)** that a single charged particle carries -
 - This value is $1.6 \times 10^{-19} \text{ C}$ for electrons.

Therefore, the current passing through a conductor can be calculated by using the formula below:

$$I = nqvA$$



Where n is the charge carrier density, q is the charge of a charge carrier, v is the drift velocity and A is the cross-sectional area of the object.

Different materials have different values of **charge carrier density (n)**, and even the same material has different values for different temperatures. This is because, when a material is given more energy (in the form of heat), some of its atoms may release more charge carriers, increasing the charge carrier density. This is why there is a **large range of resistivities** of different materials.

2.4.74 - Potential along a uniform current-carrying wire

From the equation for resistance below, you can see that the resistance of an object is dependent on its length.

$$R = \frac{\rho l}{A}$$

Consider a **uniform** current-carrying wire, which has constant resistivity and cross-sectional area. Therefore, as the length of a wire increases, its resistance will increase uniformly. Using Ohm's law ($V = IR$), you can see that as resistance increases, potential will also increase.

This means that the **potential** along a **uniform** current-carrying wire **increases uniformly with the distance along it**.

2.4.75 - Potential divider circuits

A **potential divider** is a circuit with **several resistors in series connected across a voltage source**, used to produce a required **fraction** of the source potential difference, which remains constant.

You can also make a potential divider supply a **variable** potential difference by using a **variable resistor** as one of the resistors in series, therefore by varying the resistance across it, you can vary the potential difference output. For example, if the resistance across R_1 increases, the output p.d will decrease as circuit current has decreased and $V=IR$.

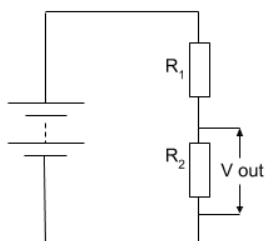

You can calculate differences and potential divider the same way as other circuits.

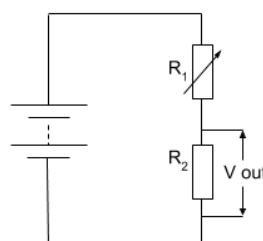

potential resistances in circuits in exactly

2.4.76 - Potential divider circuits with thermistors and LDRs

You could replace the variable resistor in the circuit above with a thermistor or light dependent resistor (LDR), in order to form a **temperature or light sensor**.



A **light dependent resistor's** resistance decreases as light intensity increases.

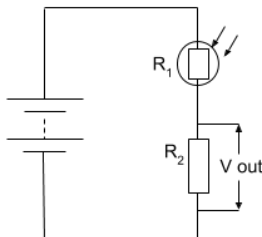

These types of sensors can be used to **trigger certain events**, for example in the circuit above, a light dependent resistor is used. If the light intensity falls, resistance across R_1 will increase. This will cause the total circuit resistance to increase and so the circuit current will decrease. Using Ohm's law ($V = IR$), you can see that this means that the voltage across R_2 decreases, so the p.d out decreases. If you want this effect to be **reversed**, you can **switch the position of the LDR and resistor**, meaning that the p.d out would increase as light intensity decreases and so this circuit could be used to cause a light bulb to be switched on, once a certain threshold voltage has been met.

2.4.77 - Electromotive force and internal resistance

Batteries have an **internal resistance (r)** which is **caused by electrons colliding** with atoms inside the battery, therefore some energy is lost before electrons even leave the battery. It is represented as a small resistor inside the battery.

Electromotive force (emf / ϵ) is the **energy transferred by a cell per coulomb of charge** that passes through it:

$$\epsilon = \frac{E}{Q}$$

Where **E** is the energy transferred and **Q** is the charge.

As you can see in the circuit below, the sum of the internal resistance (r), and load resistance (R) is equal to the total resistance (R_T) in the circuit.

$$R_T = R + r$$

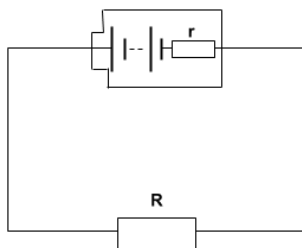

Emf is the product of the total resistance and the current of the circuit, as $V = IR$.

$$\epsilon = IR + Ir \quad \epsilon = I(R + r)$$



The p.d across the resistance R , is known as the **terminal potential difference (V)**, whereas the p.d across the resistance r , is known as **lost volts (v)** because this value is equal to the **energy wasted by the cell per coulomb of charge**.

$$V = IR \quad v = Ir$$

Therefore, emf is the sum of the terminal p.d and lost volts:

$$\varepsilon = V + v.$$

The emf of a battery can be measured by measuring the voltage across a cell using a voltmeter when there is **no** current running through the cell, which means it is in an **open circuit**.

2.4.79 - Changes of resistance with temperature in metallic conductors and NTC thermistors

The atoms in most solids are arranged in a **crystal lattice structure** as shown in the diagram below:

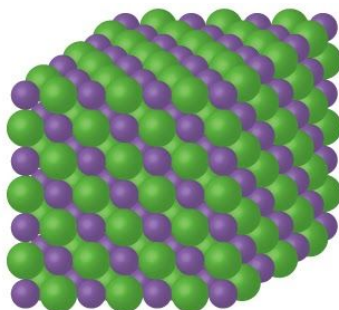

Image source: [Rice University, CC BY 4.0](https://www.rice.edu/~chem/chem101/chem101.html), Image is cropped

This lattice structure provides a medium for vibration of the atoms about their equilibrium position. As the **temperature** of the solid **increases**, the **intensity of the vibration** of its atoms also **increases**.

The more intense that the **lattice vibrations** of atoms in a material are, the more difficult it is for free electrons to pass through it. This is because the electrons will be more likely to collide with the vibrating atoms if they are oscillating more intensely, causing them to slow down. (Intensity here refers to the **speed** and **amplitude** of oscillations). This in turn **increases** the **resistance** of the material.

As the **temperature** of a metal or semiconductor **increases**, its atoms gain energy, and once they gain enough energy they begin to **release electrons** (this is known as thermionic emission). This increases the number of charge carriers available in the conductor, which **decreases** its **resistance**.





Negative temperature coefficient thermistors are designed in such a way that as their **temperature increases, their resistance decreases**. This occurs because they release a large amount of **charge carriers** as their temperature increases (outweighing the effects of lattice vibrations). Below is a graph temperature-resistance of an NTC thermistor:

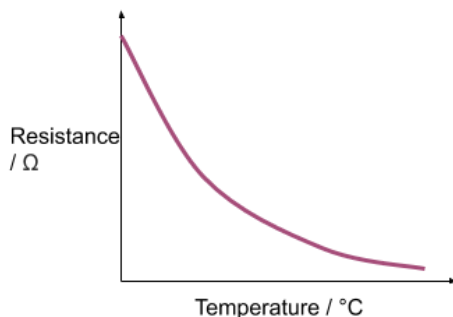

As for **metallic conductors**, as their **temperature increases, their resistance also increases** due to **lattice vibrations** in the conductor becoming more intense. More electrons are also released but not quickly enough to counter the disruptive effect of the lattice vibrations. Below is a graph temperature-resistance of a metallic conductor:

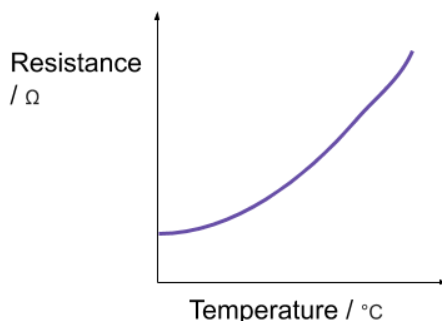

2.4.80 - Changes of resistance with light intensity

When light above a certain frequency is shone onto a metal, it releases electrons, which are known as photoelectrons. This is called the **photoelectric effect** (*this is discussed in much more detail in the notes for topic 5*).

Light-dependent resistors (LDRs) are made from **photoconductive** materials, meaning that they release electrons in the presence of light, as described above. Therefore, as light intensity increases, electrons are released, which **increases** the **number of charge carriers** available to conduct electricity, and the **resistance** of the LDR **decreases**. Below is the graph of resistance against light intensity for an LDR:

