

Write your name here

Surname

Other names

Pearson Edexcel
International
Advanced Level

Centre Number

--	--	--	--	--

Candidate Number

--	--	--	--

Decision Mathematics D1

Advanced/Advanced Subsidiary

Sample Assessment Material
Time: 1 hour 30 minutes

Paper Reference

WDM01/01

Answer Book

Do not return the question paper with the answer book.

Total Marks

S45010A

©2013 Pearson Education Ltd.



S 4 5 0 1 0 A 0 1 2 0

Turn over ►

PEARSON

1.

Hajra (H)	Vicky (V)	Leisham (L)	Alice (A)	Nicky (N)	June (J)	Sharon (S)	Tom (T)	Paul (P)
--------------	--------------	----------------	--------------	--------------	-------------	---------------	------------	-------------

2.

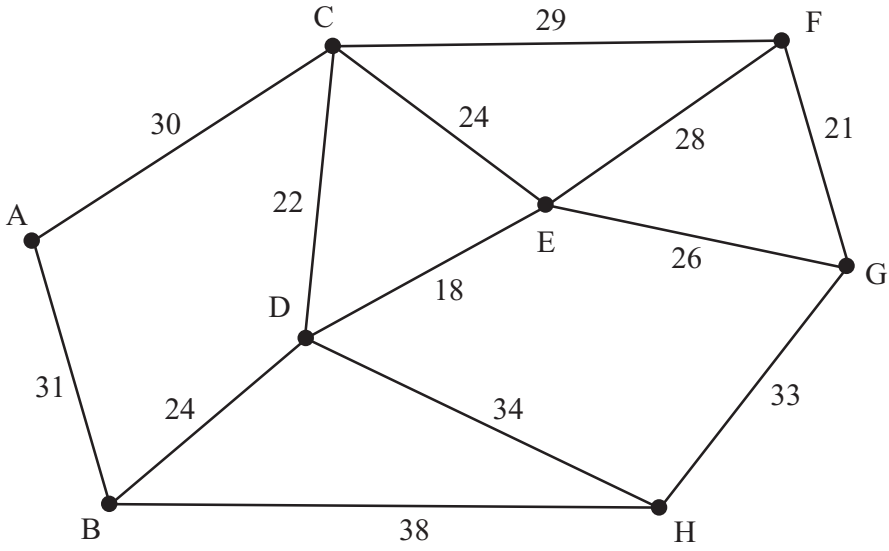

Figure 1

(a)

(b)

	A	B	C	D	E	F	G	H
A	-	31	30	-	-	-	-	-
B	31	-	-		-	-	-	38
C	30	-	-		24		-	-
D	-			-	18	-	-	
E	-	-	24	18	-	28		-
F	-	-		-	28	-	21	-
G	-	-	-	-		21	-	
H	-	38	-		-	-		-

Matrix 1

(c)

(d) Weight of minimum spanning tree: _____

(Total 9 marks)

Q2

4.

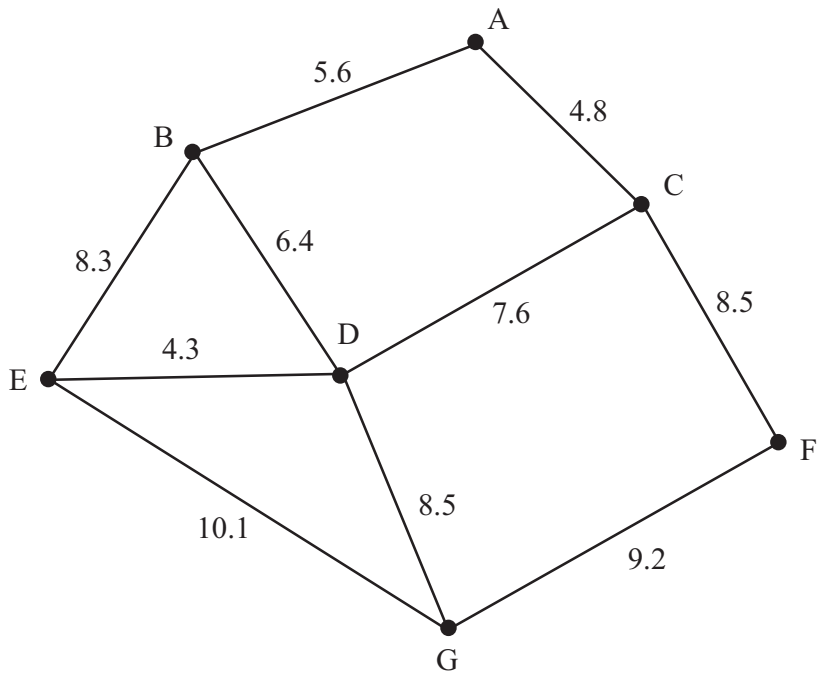

Figure 2

[The total weight of the network is 73.3 km]

Question 4 continued

Lined writing area for question 4

(Total 10 marks)

Q4

Small rectangular box for marking

Question 5 continued

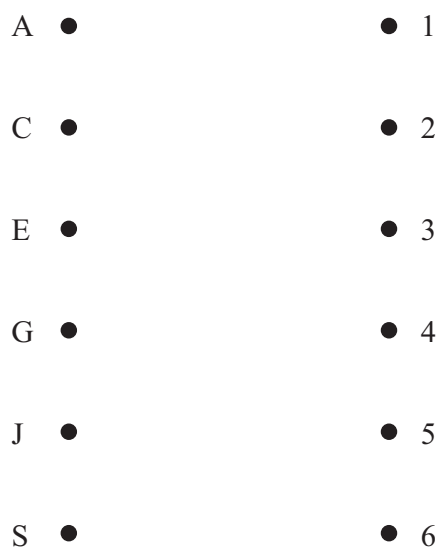
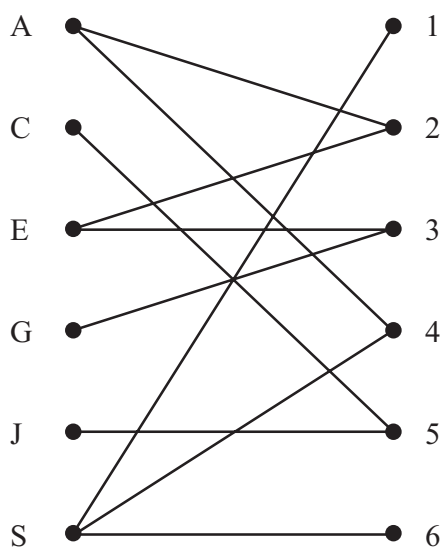

(Total 8 marks)

Q5

6.

(a)

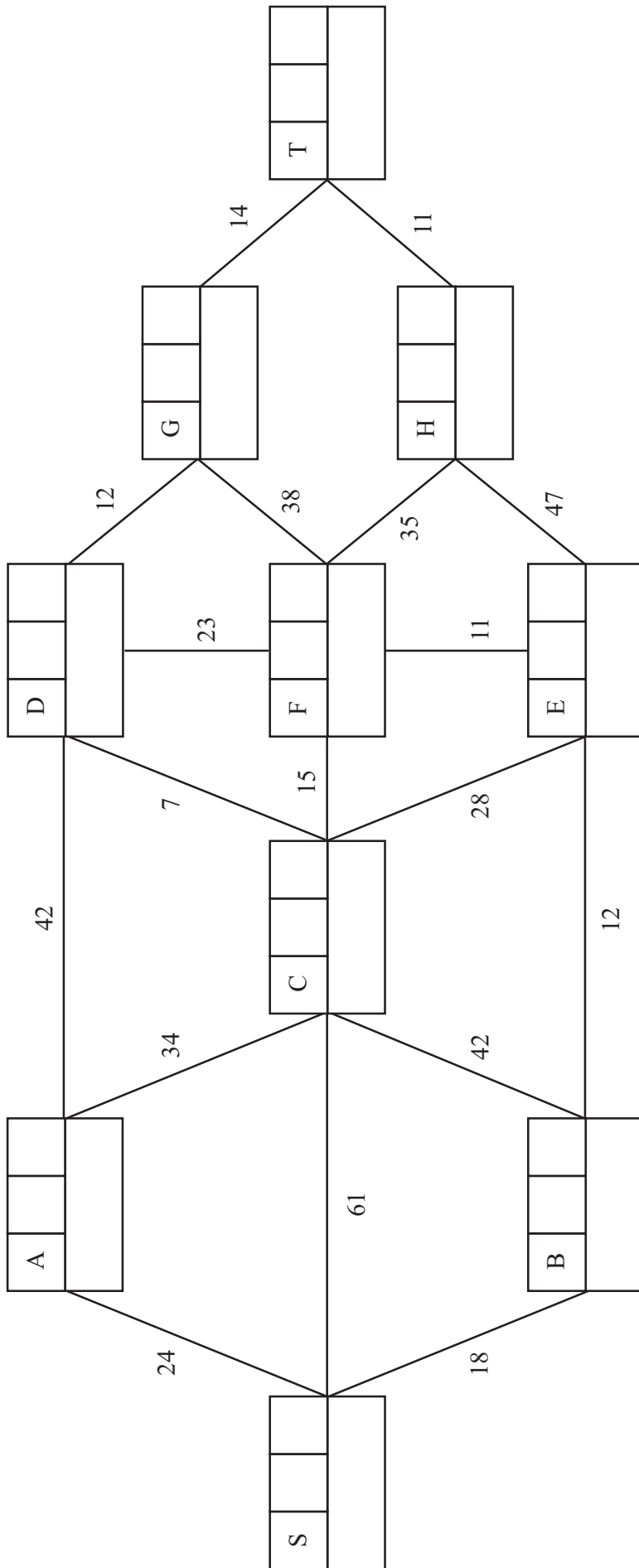

Route S to T: _____

Time taken for route: _____

Leave blank

Question 6 continued

(b)

Lined area for student response, consisting of 18 vertical lines.

(c) Route E to T:

(Total 9 marks)

Q6

7.

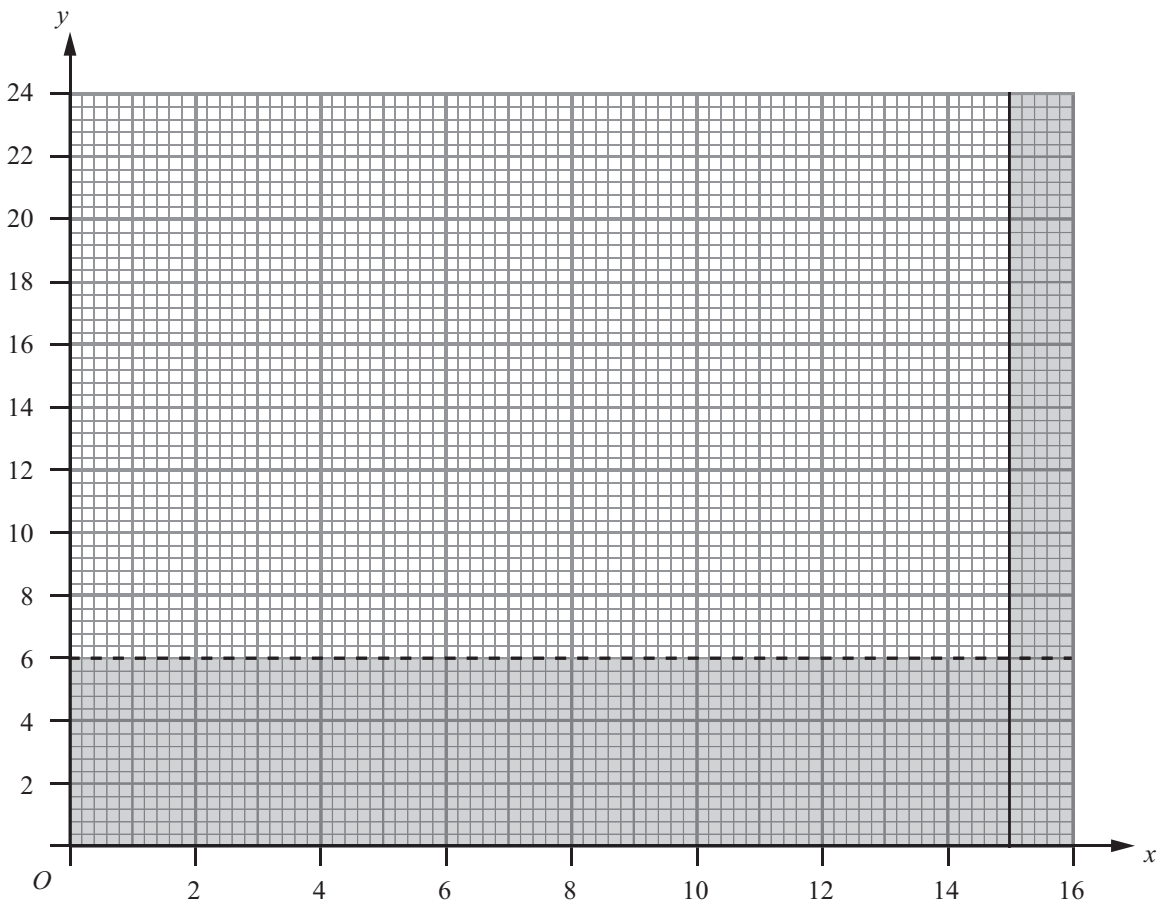

Diagram 1

8. (a)

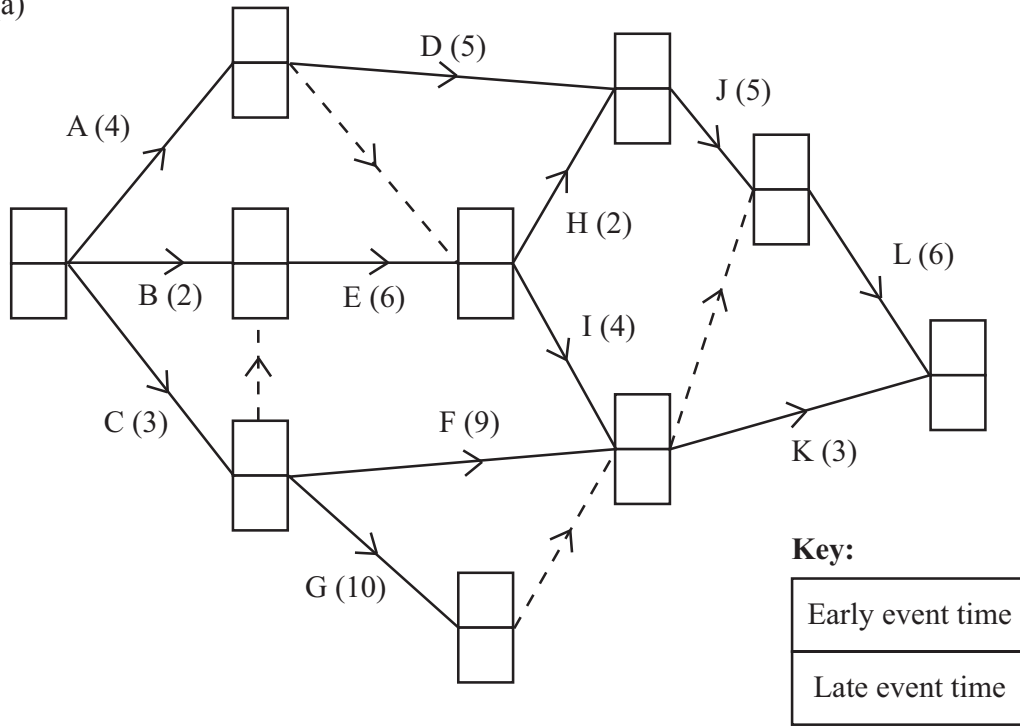
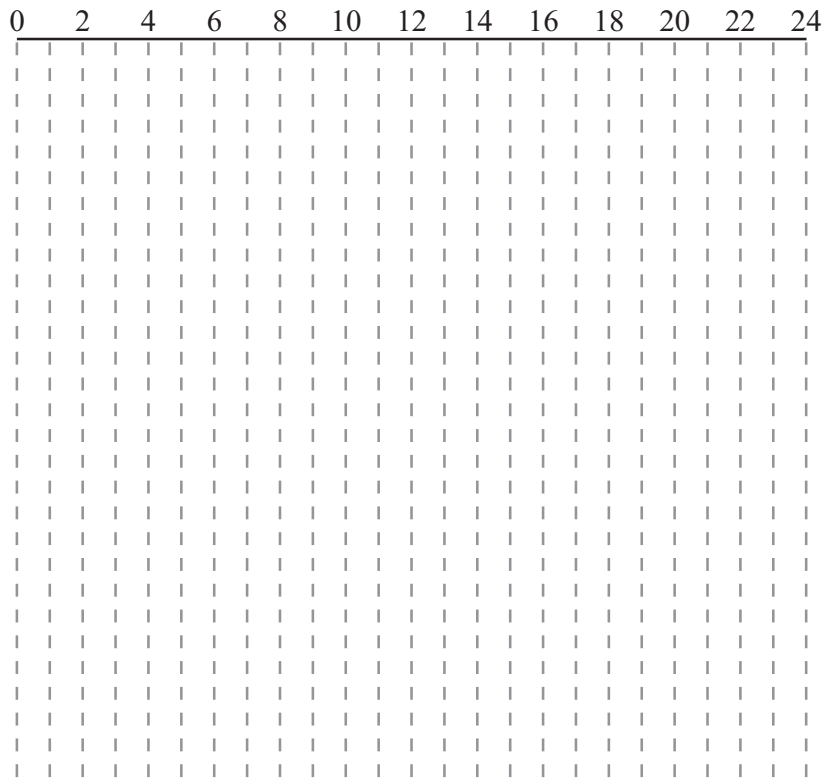

Diagram 2

(b) Critical activities: _____

(c)



Grid 1

(d)

Q8

(Total 11 marks)

TOTAL FOR PAPER: 75 MARKS

END