



**GCE**

**Chemistry A**

Unit **H432/01**: Periodic table, elements and physical chemistry

Advanced GCE

**Mark Scheme for June 2018**

OCR (Oxford Cambridge and RSA) is a leading UK awarding body, providing a wide range of qualifications to meet the needs of candidates of all ages and abilities. OCR qualifications include AS/A Levels, Diplomas, GCSEs, Cambridge Nationals, Cambridge Technicals, Functional Skills, Key Skills, Entry Level qualifications, NVQs and vocational qualifications in areas such as IT, business, languages, teaching/training, administration and secretarial skills.

It is also responsible for developing new specifications to meet national requirements and the needs of students and teachers. OCR is a not-for-profit organisation; any surplus made is invested back into the establishment to help towards the development of qualifications and support, which keep pace with the changing needs of today's society.







This mark scheme is published as an aid to teachers and students, to indicate the requirements of the examination. It shows the basis on which marks were awarded by examiners. It does not indicate the details of the discussions which took place at an examiners' meeting before marking commenced.

All examiners are instructed that alternative correct answers and unexpected approaches in candidates' scripts must be given marks that fairly reflect the relevant knowledge and skills demonstrated.

Mark schemes should be read in conjunction with the published question papers and the report on the examination.

© OCR 2018

## Annotations

Annotation	Meaning
<b>DO NOT ALLOW</b>	Answers which are not worthy of credit
<b>ALLOW</b>	Answers that can be accepted
( )	Words which are not essential to gain credit
—	Underlined words must be present in answer to score a mark
<b>AW</b>	Alternative wording
<b>ORA</b>	Or reverse argument
	Correct response
	Incorrect response
	Omission mark
	Benefit of doubt given
	Contradiction
	Rounding error

<b>SF</b>	Error in number of significant figures
<b>ECF</b>	Error carried forward
<b>L1</b>	Level 1
<b>L2</b>	Level 2
<b>L3</b>	Level 3
<b>NBOD</b>	Benefit of doubt not given
<b>SEEN</b>	Noted but no credit given
<b>I</b>	Ignore

**Subject-specific Marking Instructions****INTRODUCTION**

Your first task as an Examiner is to become thoroughly familiar with the material on which the examination depends. This material includes:

- the specification, especially the assessment objectives
- the question paper
- the mark scheme.

You should ensure that you have copies of these materials.

You should ensure also that you are familiar with the administrative procedures related to the marking process. These are set out in the OCR booklet **Instructions for Examiners**. If you are examining for the first time, please read carefully **Appendix 5 Introduction to Script Marking: Notes for New Examiners**.

Please ask for help or guidance whenever you need it. Your first point of contact is your Team Leader.

H432/01

Mark Scheme

June 2018

## SECTION A

Question	Answer	Marks	AO element	Guidance
1	C	1	AO2.2	
2	C	1	AO2.2	
3	B	1	AO2.2	
4	D	1	AO2.4	
5	A	1	AO1.2	
6	C	1	AO1.2	
7	D	1	AO2.3	
8	A	1	AO1.1	
9	B	1	AO1.2	
10	C	1	AO2.6	
11	A	1	AO1.2	
12	D	1	AO2.5	
13	B	1	AO1.1	
14	C	1	AO1.1	
15	D	1	AO1.1	
	<b>Total</b>	<b>15</b>		

H432/01

Mark Scheme

June 2018

## SECTION B

Question			Answer	Marks	Guidance
16	(a)	(i)	(enthalpy change when) 1 mole of gaseous ions react <b>OR</b> 1 mole of hydrated/aqueous ions are formed ✓  gaseous ions dissolve in <b>water</b> <b>OR</b> gaseous ions form aqueous/hydrated ions ✓	2	<b>IGNORE</b> 'energy released' <b>OR</b> 'energy required'
	(a)	(ii)	<p> <math>\text{Ca}^{2+}(\text{g}) + 2\text{F}^{-}(\text{g})</math> ✓  <math>\text{Ca}^{2+}(\text{aq}) + 2\text{F}^{-}(\text{g})</math> ✓  <math>\text{Ca}^{2+}(\text{aq}) + 2\text{F}^{-}(\text{aq})</math> ✓  <math>\text{CaF}_2(\text{s})</math> ✓ </p>	4	<p>Correct species <b>AND</b> state symbols required for each mark. (mark independently)</p> <p>On 2nd line, <b>ALLOW</b> <math>\text{Ca}^{2+}(\text{g}) + 2\text{F}^{-}(\text{aq})</math> (i.e. <math>\text{F}^{-}</math> hydrated before <math>\text{Ca}^{2+}</math>)</p> <p>On 3rd line, <b>ALLOW</b> <math>\text{CaF}_2(\text{aq})</math></p> <p><b>DO NOT ALLOW</b> when first seen but <b>ALLOW ECF</b> for '2' missing and for use of the following ions  <math>\text{Fl}^{-}</math>  <math>\text{F}_2^{-}</math>  <math>\text{Ca}^{+3+}</math></p>

Question		Answer	Marks	Guidance
(a)	(iii)	<p><b>FIRST, CHECK THE ANSWER ON ANSWER LINE</b>  <b>IF answer = <math>-504 \text{ (kJ mol}^{-1}\text{)}</math> award 2 marks</b>  <b>IF answer = <math>-1008 \text{ (kJ mol}^{-1}\text{)}</math> award 1 mark</b>            -----</p> <p><math>2 \times \Delta_{\text{hyd}}H(\text{F}^-)</math>  <math>= [-2630 + 13] - (-1609)</math>  <b>OR</b> <math>-2617 + 1609</math>  <b>OR</b> <math>-1008 \text{ (kJ mol}^{-1}\text{)}</math> ✓</p> <p><math>\Delta_{\text{hyd}}H(\text{F}^-) = \frac{-1008}{2} = -504 \text{ ✓ (kJ mol}^{-1}\text{)}</math></p>	2	<p><b>IF</b> alternative answer, check to see if there is any <b>ECF</b> credit possible using working below.</p> <p>'-' sign is needed.</p> <p><b>COMMON ERRORS</b> for 1 mark:  <math>(+)</math>2694: <i>signs all reversed</i>  <math>-2113</math>: <i>sign wrong for <math>-1609</math></i>  <math>-2126</math>: <i>sign wrong for 2630</i>  <math>-517</math>: <i>sign wrong for 13</i>  <math>+504</math>: <i>sign wrong</i></p> <p><b>IF ALL 3</b> relevant values from the information at the start of Q16a(iii) have <b>NOT</b> been used, award zero marks unless one number has a transcription error, where 1 mark can be awarded <b>ECF</b></p>
(a)	(iv)	<p><b>Correct comparison of <math>\Delta_{\text{hyd}}</math> linked to sizes</b>  <math>\Delta_{\text{hyd}}H(\text{F}^-)</math> more negative/exothermic (than <math>\Delta_{\text{hyd}}H(\text{Cl}^-)</math>)  <b>AND</b>  <math>\text{F}^-</math> has smaller size (than <math>\text{Cl}^-</math>) ✓</p> <p><b>Comparison of attraction between ions and water</b>  <math>\text{F}^-</math> OR smaller sized ion linked to greater attraction to <math>\text{H}_2\text{O}</math> ✓</p>	2	<p><b>ORA</b>  <b>IGNORE</b> 'atomic' before radius when comparing size of ions  <b>IGNORE</b> charge density</p> <p><b>IGNORE</b> electronegativity  <b>IGNORE</b> nuclear attraction  <b>DO NOT ALLOW</b> 'forms stronger hydrogen bonds with water' <b>OR</b> 'forms stronger van der Waals' forces with water'  <b>ALLOW</b> 'forms bonds' for attraction'  <b>DO NOT ALLOW</b> <math>\text{F}^-</math> greater attraction to <math>\text{H}_2\text{O}</math> if given as larger ion            Assume 'F' / 'Fluorine' means 'ions' but <b>DO NOT ALLOW</b> 'F molecules'</p>



H432/01

Mark Scheme

June 2018

Question		Answer	Marks	Guidance
	(b) (i)	<p><b>Average bond enthalpy</b></p> <p>Breaking of one mole of bonds ✓</p> <p>In gaseous molecules ✓</p>	2	<p><b>IGNORE</b> energy required <b>OR</b> energy released <b>IGNORE</b> heterolytic / homolytic</p> <p><b>DO NOT ALLOW</b> bonds formed</p> <p><b>DO NOT ALLOW</b> ionic bonds</p> <p><b>IGNORE</b> species for molecules</p>
	(b) (ii)	<p><b>FIRST, CHECK ANSWER ON ANSWER LINE</b></p> <p><b>IF answer = (+) 158 award 3 marks</b></p> <p>-----</p> <p><b>Bond enthalpy of F–F</b></p> <p>(<math>\Delta H</math> for (O–H) bonds broken =) 1856 <b>OR</b> <math>4 \times 464</math> (kJ mol<sup>-1</sup>) ✓</p> <p>(<math>\Delta H</math> for bonds made =) 2770 (kJ mol<sup>-1</sup>) <b>OR</b> 498 <b>AND</b> 2272 (kJ mol<sup>-1</sup>) <b>OR</b> 498 <b>AND</b> <math>4 \times 568</math> (kJ mol<sup>-1</sup>) ✓</p> <p>(bond enthalpy) F–F = <math>\frac{2770 - 1856 - 598}{2}</math> = (+)158 (kJ mol<sup>-1</sup>) ✓</p>	3	<p><b>ANNOTATE ANSWER WITH TICKS AND CROSSES</b></p> <p><b>IGNORE</b> sign</p> <p><b>IGNORE</b> sign</p> <p><b>ALLOW ECF</b></p> <p><b>Common errors</b></p> <p><b>Award 2 marks</b> for; –158 (Wrong sign) (±)316 (No ÷ 2) (+) 622 (use of 2 x 464) (+) 457 (omitting – 598) (+) 756 (use of +598)</p> <p><b>Award 1 mark</b> for; (+) 970 (use of 2 x 464 and +598)</p>
		<b>Total</b>	<b>15</b>	

Question	Answer	Marks	Guidance
17 (a)*	<p><i>Please refer to the marking instructions on page 5 of this mark scheme for guidance on how to mark this question.</i></p> <p><b>Level 3 (5–6 marks)</b> A comprehensive conclusion which uses quantitative results for determination of the reaction orders. <b>AND</b> Determines <math>k</math> from correct rate equation. <b>AND</b> Proposes the two-step mechanism which adds up to overall equation <i>with no intermediate electrons</i>.</p> <p><i>There is a well-developed line of reasoning which is clear and logically structured. The information presented is relevant and substantiated. The working for the scientific content is clearly linked to the experimental evidence.</i></p> <p><b>Level 2 (3–4 marks)</b> Reaches a sound, but not comprehensive, conclusion based on the quantitative results. <b>AND</b> Correctly identifies the orders and rate equation. <b>AND</b> Calculates the rate constant <b>OR</b> Proposes the two-step mechanism with reactants of first step matching rate equation or matches orders</p> <p><i>There is a line of reasoning presented with some structure. The information presented is relevant and supported by some evidence. The working for the scientific content is clearly linked to the experimental evidence.</i></p>	6	<p><b>Indicative scientific points may include:</b></p> <p><b>Orders and rate equation</b></p> <ul style="list-style-type: none"> <li>• <math>\text{Fe}^{3+}</math> 1st order <b>AND</b> <math>\text{I}^-</math> 2nd order <b>OR</b> <math>\text{rate} = k[\text{Fe}^{3+}][\text{I}^-]^2</math></li> <li>• Supported by experimental results</li> </ul> <p><b>Calculation of <math>k</math>, including units</b></p> <ul style="list-style-type: none"> <li>• <math>k</math> correctly calculated <b>AND</b> correct units, e.g. <math display="block">k = \frac{8.10 \times 10^{-4}}{(4.00 \times 10^{-2}) \times (3.00 \times 10^{-2})^2} = 22.5</math></li> <li>• <math>\text{dm}^6 \text{mol}^{-2} \text{s}^{-1}</math> <b>OR</b> <math>\text{mol}^{-2} \text{dm}^6 \text{s}^{-1}</math></li> </ul> <p><b>Two-step mechanism</b></p> <ul style="list-style-type: none"> <li>• Two steps add up to give overall equation</li> <li>• Slow step/ rate-determining step matches stoichiometry of rate equation.</li> <li>• Each step balances by species and charge</li> </ul> <p><b>e.g.</b>  <math>\text{Fe}^{3+}(\text{aq}) + 2\text{I}^-(\text{aq}) \rightarrow [\text{FeI}_2]^+ \quad \text{SLOW}</math>  <math>\text{Fe}^{3+}(\text{aq}) + [\text{FeI}_2]^+ \rightarrow 2\text{Fe}^{2+}(\text{aq}) + \text{I}_2(\text{aq}) \quad \text{FAST}</math></p> <p><math>\text{Fe}^{3+}(\text{aq}) + 2\text{I}^-(\text{aq}) \rightarrow \text{Fe}^{2+}(\text{aq}) + \text{I}_2^-(\text{aq}) \quad \text{SLOW}</math>  <math>\text{Fe}^{3+}(\text{aq}) + \text{I}_2^-(\text{aq}) \rightarrow \text{Fe}^{2+}(\text{aq}) + \text{I}_2(\text{aq}) \quad \text{FAST}</math></p> <p><math>\text{Fe}^{3+}(\text{aq}) + 2\text{I}^-(\text{aq}) \rightarrow \text{Fe}^+ + \text{I}_2 \quad \text{SLOW}</math>  <math>\text{Fe}^{3+}(\text{aq}) + \text{Fe}^+ \rightarrow 2\text{Fe}^{2+}(\text{aq}) \quad \text{FAST}</math></p> <p>There may be other feasible possibilities</p>

H432/01

Mark Scheme

June 2018

Question	Answer	Marks	Guidance
	<p><b>Level 1 (1–2 marks)</b> Attempts to reach a simple conclusion for orders <b>AND</b> Attempts a relevant rate equation.</p> <p><i>There is an attempt at a logical structure with a line of reasoning. The information is in the most part relevant The working for the scientific content is clearly linked to the experimental evidence.</i></p> <p><b>0 marks</b> No response or no response worthy of credit.</p>		

H432/01

Mark Scheme

June 2018

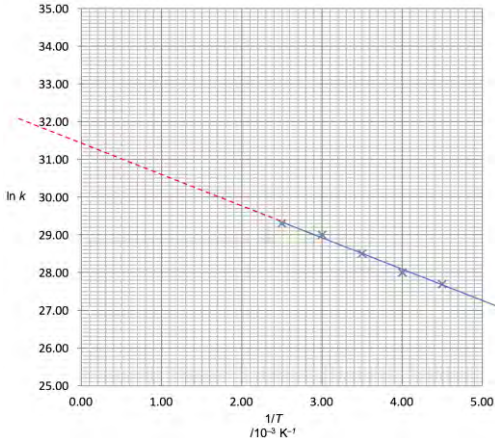
Question		Answer	Marks	Guidance
(b)	(i)	 <p><b>Gradient</b> Correct gradient calculated from best-fit straight line drawn within the range <math>\pm 800 \rightarrow \pm 1040</math> ✓</p> <p><b><math>E_a</math> calculation</b> <math>E_a = (-) \text{ gradient} \times 8.314</math> ✓ e.g. from <math>\pm 820</math>, <math>E_a = (+)6817.48</math> (J mol<sup>-1</sup>)</p> <p><b><math>E_a</math> to 3 SF AND</b> use of <math>10^{-3}</math> for gradient ✓ e.g. from <math>\pm 820</math>, <math>E_a = (+)6820</math> (J mol<sup>-1</sup>)</p>	3	<p><b>ALLOW</b> lines which do not intercept y-axis</p> <p><b>ALLOW</b> mark for gradient if correct working shown within <math>E_a</math> calculation without gradient being calculated separately</p> <p><b>ALLOW</b> <math>\pm 0.8(00) \rightarrow \pm 1.04(0)</math> (omission of <math>10^{-3}</math>)</p> <p><b>ALLOW</b> ECF for calculated gradient x 8.314 If value of gradient not shown separately, <b>ALLOW</b> <math>E_a</math> in range: 6650 <math>\rightarrow</math> 8650 <b>OR</b> 6.65 <math>\rightarrow</math> 8.65 (omission of <math>10^{-3}</math>)</p> <p><b>This mark subsumes gradient mark</b></p> <p><b>NOTE:</b> Omission of <math>10^{-3}</math> can get 1st 2 marks</p>

H432/01

Mark Scheme

June 2018

Question	Answer	Marks	Guidance
	<p>(ii) Intercept shown on graph could be by extrapolation of line, or label on y axis <b>AND</b> ln A linked to intercept value e.g. <math>\ln A = 31.4 \checkmark</math></p> <p>Calculation of <math>A = e^{\text{intercept}} \checkmark</math> e.g. <math>A = e^{31.4} = 4.33 \times 10^{13}</math></p>	2	<p><b>ALLOW</b> <math>y = 31.4</math></p> <p><b>ALLOW</b> substitution of correct values of ln k and 1/T into <math>\ln k = -E_a/R \times 1/T + \ln A</math> to give a value of ln A which approximately matches the intercept if given</p> <p><math>\ln A = \ln k + (E_a/R \times 1/T)</math></p> <p>Calculation of <math>A = e^{\ln A}</math></p> <p><b>OR</b> <math>e^{\ln k + (E_a/R \times 1/T)}</math></p> <p><b>ALLOW</b> ECF from incorrect ln A</p> <p><math>e^{31.2} = 3.55 \times 10^{13}</math>  <math>e^{31.3} = 3.92 \times 10^{13}</math>  <math>e^{31.35} = 4.12 \times 10^{13}</math>  <math>e^{31.45} = 4.56 \times 10^{13}</math>  <math>e^{31.5} = 4.79 \times 10^{13}</math>  <math>e^{31.6} = 5.29 \times 10^{13}</math>  <math>e^{31.7} = 5.85 \times 10^{13}</math>  <math>e^{31.8} = 6.46 \times 10^{13}</math>  <math>e^{31.9} = 7.14 \times 10^{13}</math>  <math>e^{32.0} = 7.9(0) \times 10^{13}</math>  <math>e^{32.1} = 8.73 \times 10^{13}</math></p> <p>IF 2 DP answer given, check rounding from calculator value, not 3 DP values given Eg <math>e^{31.7} = 5.8497 \times 10^{13}</math> and <math>= 5.8 \times 10^{13}</math> (2SF)</p>
	<b>Total</b>	<b>11</b>	

H432/01

Mark Scheme

June 2018

Question		Answer	Marks	Guidance
18	(a)	$K_c = \frac{[\text{NO}_2]^2}{[\text{NO}]^2 [\text{O}_2]} \checkmark$ <p>Units = <math>\text{dm}^3 \text{mol}^{-1} \checkmark</math></p>	2	<p>Must be square brackets <b>IGNORE</b> state symbols</p> <p><b>ALLOW</b> <math>\text{mol}^{-1} \text{dm}^3</math> <b>ALLOW</b> <math>\text{mol dm}^{-3}</math> as ECF from inverted <math>K_c</math> expression</p>
	(b)	<p><b>FIRST CHECK THE ANSWER ON THE ANSWER LINE IF answer = 1.2 (mol) award 4 marks</b></p> <p><b>Unless otherwise stated, marks are for correctly calculated values. Working shows how values have been derived.</b></p> <p><math>[\text{NO}] = \frac{0.40}{4.0} = 0.1(0) \text{ (mol dm}^{-3}\text{)}</math> <b>AND</b> <math>[\text{O}_2] = \frac{0.80}{4.0} = 0.2(0) \text{ (mol dm}^{-3}\text{)} \checkmark</math></p> <p><math>[\text{NO}_2]^2 = 45 \times 0.10^2 \times 0.20 \text{ OR} = 0.09(0) \checkmark</math> <math>[\text{NO}_2] = \sqrt{(45 \times 0.10^2 \times 0.20)} \text{ OR} = 0.3(0) \text{ (mol dm}^{-3}\text{)} \checkmark</math> amount <math>\text{NO}_2 = 0.30 \times 4 = 1.2 \text{ (mol)} \checkmark</math></p>	4	<p><b>ANNOTATIONS MUST BE USED</b> For <b>all</b> parts, <b>ALLOW</b> numerical answers from 2 significant figures up to the calculator value</p> <p>Ignore rounding errors after second significant figure</p> <p>1st mark is for realising that concentrations need to be calculated.</p> <p><b>ALLOW ECF</b></p> <p><b>Correct numerical answer with no working would score all previous calculation marks</b></p> <p>Making point 2 subsumes point 1</p> <p>Making point 3 subsumes points 2 and 1</p> <p>Common errors 9.6 = 3 marks mol of NO and O<sub>2</sub> used 0.36 = 3 marks mol of NO<sub>2</sub> calculated from <math>[\text{NO}_2]^2</math> 2.4 = 2 marks mol of NO and O<sub>2</sub> used and no mol of NO<sub>2</sub> calculated</p>

H432/01

Mark Scheme

June 2018

Question		Answer	Marks	Guidance
	(c) (i)	Exothermic <b>AND</b> $K_p$ decreases as temperature increases ✓	1	<b>ALLOW</b> $K_c$ for $K_p$ <b>ALLOW</b> Equilibrium shifts to left hand side as temperature increases
	(c) (ii)	<b>Equilibrium shift</b> (Equilibrium position) shifts to right / forward / towards products ✓  <b>Effect of increased pressure on <math>K_p</math> expression</b> Ratio (in $K_p$ expression) decreases <b>OR</b> Denominator/bottom of $K_p$ expression increases more (than numerator/top) ✓  <b>Equilibrium shift (<math>K_p</math> expression)</b> Ratio (in $K_p$ expression) increases <b>to restore <math>K_p</math></b> <b>OR</b> Numerator/top of $K_p$ expression increases <b>to restore <math>K_p</math></b> ✓	3	<b>FULL ANNOTATIONS NEEDED</b> <b>ALLOW</b> $K_c$ for $K_p$ throughout the response.  <b>ALLOW</b> $K_p$ (initially) decreases for second marking point <b>IF</b> $K_p$ is seen to be restored later in the process.  <b>ALLOW</b> more $\text{NO}_2$ / product formed to restore $K_p$ <b>ALLOW</b> ratio adjusts to restore $K_p$
		<b>Total</b>	<b>10</b>	

H432/01

Mark Scheme

June 2018

Question			Answer	Marks	Guidance
19	(a)	(i)	$K_a = \frac{[H^+][CH_3COO^-]}{[CH_3COOH]}$ ✓	1	<b>IGNORE</b> state symbols Must be square brackets <b>IGNORE</b> expressions with HA or with $[H^+]^2$
		(ii)	<p><b>FIRST, CHECK ANSWER ON ANSWER LINE IF answer = 4.76 award 3 marks</b></p> <p>-----</p> <p><math>[H^+] = 10^{-pH}</math>  <math>= 10^{-2.41} = 3.89 \times 10^{-3} \text{ (mol dm}^{-3}\text{)} \checkmark</math></p> <p><math>K_a</math>  <math>= \frac{[H^+]^2}{[CH_3COOH]} = \frac{(3.89 \times 10^{-3})^2}{0.870}</math>  <math>= 1.74 \times 10^{-5} \text{ (mol dm}^{-3}\text{)} \checkmark</math></p> <p><math>pK_a</math>  <math>= -\log K_a = -\log 1.74 \times 10^{-5} = 4.76 \checkmark</math></p>	3	<p><b>ALLOW</b> use of HA and A<sup>-</sup></p> <p><b>ALLOW 3 SF</b> up to calculator value of:  <math>3.89045145 \times 10^{-3}</math> correctly rounded</p> <p><math>K_a</math> <math>1.739725573 \times 10^{-5}</math>  <b>NOTE:</b> <math>1.74 \times 10^{-5}</math> is same from unrounded <math>[H^+]</math> calculator value and 3 SF <math>[H^+]</math> value</p> <p><b>2 DP required</b></p>
		(iii)	<p>% dissociation = <math>\frac{[H^+]}{[CH_3COOH]} \times 100</math>  <math>= \frac{3.89 \times 10^{-3}}{0.870} \times 100 = 0.447(\%) \checkmark</math></p>	1	<b>3 SF required</b>



H432/01

Mark Scheme

June 2018

Question	Answer	Marks	Guidance
(b)	<p><b>FIRST, CHECK ANSWER ON ANSWER LINE IF answer = 95.9(%) award 4 marks</b></p> <p>-----</p> <p><math>[H^+] = 10^{-pH}</math>  <math>= 10^{-13.48} = 3.31 \times 10^{-14} \text{ (mol dm}^{-3}\text{)} \checkmark</math></p> <p><b>[OH<sup>-</sup>] from <math>K_w</math></b>  <math>= \frac{1.00 \times 10^{-14}}{3.31 \times 10^{-14}} = 0.302 \text{ (mol dm}^{-3}\text{)} \checkmark</math></p> <p><b>Mass of (NaOH)</b>  <math>= 0.302 \times \frac{100}{1000} \times 40.0 = 1.21 \text{ (g)} \checkmark</math></p> <p><b>% of NaOH to 3 SF</b>  <math>= \frac{1.21}{1.26} \times 100 = 95.9 \text{ (%) } \checkmark</math></p>	4	<p><b>ALLOW ECF</b> throughout</p> <p><b>IGNORE</b> rounding errors beyond 3<sup>rd</sup> SF throughout</p> <p><b>ALLOW</b> <math>3.3 \times 10^{-14} \text{ (mol dm}^{-3}\text{)}</math></p> <p><b>ALLOW</b> 0.30  <b>ALLOW</b> 0.303 if <math>3.3 \times 10^{-14}</math> used in the first marking point</p> <p><b>ALLOW</b> pOH method;  pOH = 14 – 13.48 = 0.52  <math>[OH^-] = 10^{-0.52} = 0.302 \text{ (mol dm}^{-3}\text{)}</math></p> <p><b>ALLOW</b> <math>[OH^-] \times 0.1 \times 40</math></p> <p>Rounding <math>[OH^-]</math> to 0.3(0) gives 1.2/1.26 = 95.2%  Award 4 marks  Rounding <math>[OH^-]</math> to 0.303 gives 1.212/1.26 = 96.2%  Award 4 marks</p>

H432/01

Mark Scheme

June 2018

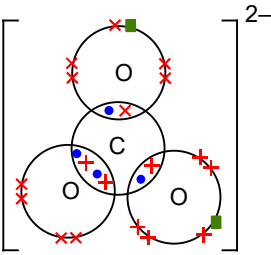
Question	Answer	Marks	Guidance
(c)	<div style="text-align: center;">  </div> <p><b>Global rules</b></p> <ul style="list-style-type: none"> <li>• C and O electrons must be shown differently, e.g. • for C and × for O</li> <li>• Na electrons shown with different symbol</li> </ul> <p><b>MARKING</b></p> <p><b>Bonding around central C atom ✓</b></p> <ul style="list-style-type: none"> <li>• 4 electrons for C shown as • <b>OR</b> ×</li> <li>• 4 electrons for O, different from C as • <b>OR</b> ×</li> <li>• C=O bond with 2 C electrons <b>AND</b> 2 O electrons</li> <li>• Two C–O bonds with 1 C electron <b>AND</b> 1 O electron</li> </ul> <p><b>Non-bonded (nb) electrons around 3 O atoms ✓</b></p> <ul style="list-style-type: none"> <li>• C=O oxygen has 4 nb 'O' electrons</li> <li>• Each C–O oxygen has 5 nb 'O' electrons <b>AND</b> 1 'extra' electron with different symbol</li> </ul>	2	<p><b>NOT REQUIRED</b></p> <ul style="list-style-type: none"> <li>• Charge ('2-') <b>IGNORE</b> incorrect charges</li> <li>• Brackets</li> <li>• Circles</li> </ul> <p><b>IGNORE</b> inner shells</p> <p><b>ALLOW</b> rotated diagram</p> <p><b>ALLOW</b> diagram with missing C or O symbols.</p> <p>In <b>C=O bond</b>, <b>ALLOW</b> sequence × × • •</p> <p>In <b>C–O bond</b>, <b>ALLOW</b> 'extra' electron with different symbol for O electron</p> <p><b>ALLOW</b> non-bonding electrons unpaired</p> <p><b>ALLOW</b> 'extra' electron as • <b>OR</b> × if it has been <b>labelled</b> 'extra electron' or similar</p>
	<b>Total</b>	11	

H432/01

Mark Scheme

June 2018

Question		Answer	Marks	Guidance
20	(a)	<p><b>ASSUME</b> trend is down the group (unless stated otherwise)</p> <p><b>Forces</b> London forces increase <b>OR</b> induced dipole(–dipole) interactions increase ✓</p> <p><b>Reason</b> (Number of) electrons increases ✓</p> <p><b>Link to energy and particles</b> More energy to break intermolecular forces <b>OR</b> to break London forces <b>OR</b> to break induced dipole(–dipole) interactions ✓</p>	3	<p><b>FULL ANNOTATIONS MUST BE USED</b> ----- <b>ALLOW</b> reverse argument throughout</p> <p><b>IGNORE</b> van der Waals'/vdW forces <b>DO NOT ALLOW</b> hydrogen bonds <b>OR</b> permanent dipole(-dipole) interactions for first and third marking points</p> <p><b>ALLOW</b> more (electron) shells</p> <p><b>DO NOT ALLOW</b> covalent bonds break</p>

H432/01

Mark Scheme

June 2018

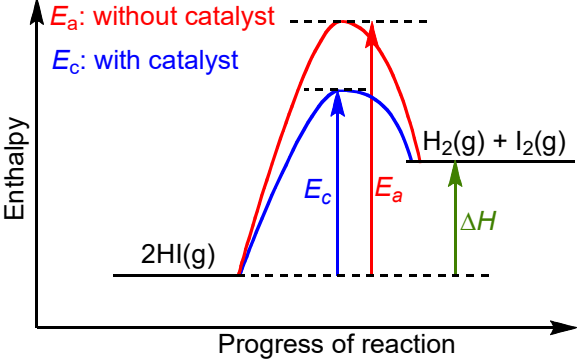
Question	Answer	Marks	Guidance
(b)	 <p>2HI(g) on LHS <b>AND</b> H<sub>2</sub>(g) + I<sub>2</sub>(g) on RHS ✓</p> <p>ΔH labelled with product above reactant <b>AND</b> arrow upwards ✓</p> <p>E<sub>a</sub> <b>AND</b> E<sub>c</sub> correctly labelled with E<sub>c</sub> below E<sub>a</sub> ✓</p>	3	<p><b>FULL ANNOTATIONS MUST BE USED</b></p> <p>Mark each point independently</p> <p><b>IGNORE</b> state symbols.</p> <p>ΔH: <b>DO NOT ALLOW</b> -ΔH. <b>ALLOW</b> ΔH arrow even with a gap at the top and bottom, i.e. does not quite reach reactant or product line</p> <p>E<sub>a</sub>: <b>ALLOW</b> no arrowhead or arrowheads at both ends of E<sub>a</sub> line E<sub>a</sub> line must reach (near or not too far beyond) maximums regardless of position</p> <p><b>ALLOW</b> AE or EA for E<sub>a</sub></p> <p>Exothermic diagram can access the first and third marks</p>

Question	Answer	Marks	Guidance
(c)	<p><b>FIRST CHECK THE ANSWER ON THE ANSWER LINE</b>  <b>IF <math>M = 183</math> AND Formula = <math>\text{Cl}_2\text{O}_7</math> award 4 marks</b>  <b>IF <math>M = 183</math> award 3 marks</b></p> <p>-----</p> <p><b>Use of data and unit conversions</b></p> <ul style="list-style-type: none"> <li>• (R = 8.314)</li> <li>• T in K: 373K</li> <li>• V in <math>\text{m}^3</math>: <math>76.0 \times 10^{-6}</math></li> <li>• (p in Pa: <math>1.00 \times 10^5</math>) ✓</li> </ul> <p><b>Calculation of n</b></p> $n = \frac{(1.00 \times 10^5) \times (76.0 \times 10^{-6})}{8.314 \times 373}$ $n = 2.45 \times 10^{-3} \text{ (mol) } \checkmark$ <p><b>Molar mass</b></p> $M = \frac{m}{n} = \frac{0.4485}{2.45 \times 10^{-3}} = 183 \text{ (g mol}^{-1}\text{)} \checkmark$ <p><b>Molecular formula</b></p> <p><math>\text{Cl}_2\text{O}_7</math> ✓</p>	4	<p>If there is an alternative answer, check to see if there is any ECF credit possible using working below</p> <p>Correct value of n subsumes first mark</p> <p><b>ALLOW ECF</b> from incorrectly calculated n</p> <p><b>ALLOW ECF</b> from incorrect M if formula of <math>\text{Cl}_x\text{O}_y</math> is the <b>closest</b> to the with <b>calculated</b> value of M</p> <p><b>IGNORE</b> use of <math>24\,000 \text{ cm}^3</math> for calculation of n  <b>BUT</b> then Mark molar mass and Molecular formula by <b>ECF</b> for two marks maximum.</p> $n = \frac{76.0}{24000} = 3.17 \times 10^{-3} \text{ (mol)}$ $M = \frac{0.4485}{3.17 \times 10^{-3}} = 141.6/141.5 \text{ (g mol}^{-1}\text{)} \checkmark$ <p>Molecular formula = <math>\text{Cl}_3\text{O}_2</math> ✓</p>

H432/01

Mark Scheme

June 2018

Question		Answer	Marks	Guidance
(d)	(i)	Titres correct and <b>ALL</b> recorded to <b>2 decimal places</b> Titre: 24.00    23.40    23.75    23.85 ✓ mean titre = 23.80 (cm <sup>3</sup> ) ✓	<b>2</b>	<b>ALLOW</b> 23.8 cm <sup>3</sup>
(d)	(ii)	Percentage uncertainty = $\frac{0.05 \times 2}{23.40} \times 100 = 0.43 (\%)$ ✓	<b>1</b>	<b>ALLOW ECF</b> from incorrect subtraction in (i) or incorrect mean <b>ALLOW</b> 0.42% from titre values 2, 3 or 4 or mean titre or trial titre. <b>2 DP required</b>
(d)	(iii)	Add starch (near the end point) ✓ Blue to colourless ✓	<b>2</b>	<b>ALLOW</b> blue/black <b>OR</b> black <b>OR</b> purple for colour of mixture <b>ALLOW</b> blue colour disappears (to colourless) <b>IGNORE</b> 'clear' <b>IGNORE</b> 'colorimetry'

H432/01

Mark Scheme

June 2018

Question		Answer	Marks	Guidance
(d)	(iv)	<p><b>FIRST CHECK THE ANSWER ON THE ANSWER LINE</b>  <b>IF B = RbIO<sub>3</sub> AND relative formula mass = 260.5 award 5 marks</b>  <b>IF relative formula mass = 260.5 award 4 marks</b></p> <p>-----</p> <p><b><math>n(\text{S}_2\text{O}_3^{2-})</math> in titration</b>  <math>= \frac{0.150 \times 23.80}{1000} = 3.57 \times 10^{-3} \text{ (mol) } \checkmark</math></p> <p><b><math>n(\text{IO}_3^-)</math> in titration</b>  <math>= \frac{3.57 \times 10^{-3}}{6} = 5.95 \times 10^{-4} \text{ (mol) } \checkmark</math></p> <p><b><math>n(\text{IO}_3^-)</math> in original 250 cm<sup>3</sup></b>  <math>= 10 \times 5.95 \times 10^{-4} = 5.95 \times 10^{-3} \text{ (mol) } \checkmark</math></p> <p><b>Relative formula mass of B</b>  <math>= \frac{1.55}{5.95 \times 10^{-3}} = 260.5 \text{ (g mol}^{-1}\text{) } \checkmark</math></p> <p><b>Formula of B (must be derived from relative formula mass)</b>            iodate of Group 1 metal that most closely matches calculated molar mass of <b>B</b></p> <p>Formula from 260.5 = RbIO<sub>3</sub> ✓</p>	5	<p><b>ALLOW ECF</b> from incorrect mean titre in (a)(i)</p> <p><b>ECF</b> from <math>n(\text{S}_2\text{O}_3^{2-})</math> in titration  <b>ALLOW</b> a two-step calculation  <math>n(\text{I}_2) = n(\text{S}_2\text{O}_3^{2-}) \div 2</math> and <math>n(\text{IO}_3^-) = n(\text{I}_2) \div 3</math></p> <p><b>ECF</b> from <math>n(\text{IO}_3^-)</math> in titration</p> <p><b>ECF</b> from <math>n(\text{IO}_3^-)</math> in original 250 cm<sup>3</sup>  <b>IF</b> scaling <math>\times 10</math> is omitted,  <b>ALLOW ECF</b> from <math>n(\text{IO}_3^-)</math> in titration</p> <p><b>ALLOW ECF</b> from incorrect RFM of <b>B</b> provided metal is from Group 1  <b>ALLOW</b> RbIO<sub>3</sub><sup>-</sup>  <b>DO NOT ALLOW</b> RbIO<sub>3</sub> without relative formula mass value.  <b>DO NOT ALLOW</b> 260.4 (without working) and RbIO<sub>3</sub>  <b>IF B = RbIO<sub>3</sub> AND relative formula mass = 261 award 5 marks</b></p>
		<b>Total</b>	<b>20</b>	

H432/01

Mark Scheme

June 2018

Question		Answer	Marks	Guidance
21	(a)	Ni: $1s^2 2s^2 2p^6 3s^2 3p^6 3d^8 4s^2$ ✓ Ni <sup>2+</sup> : $1s^2 2s^2 2p^6 3s^2 3p^6 3d^8$ ✓	2	<b>ALLOW</b> 4s before 3d, ie $1s^2 2s^2 2p^6 3s^2 3p^6 4s^2 3d^8$ <b>ALLOW</b> $1s^2$ written after answer prompt (ie $1s^2$ twice) <b>ALLOW</b> upper case D, etc and subscripts, e.g. ....4S <sub>2</sub> 3D <sub>8</sub> <b>ALLOW</b> for Ni <sup>2+</sup> .....4s <sup>0</sup> <b>DO NOT ALLOW</b> [Ar] as shorthand for $1s^2 2s^2 2p^6 3s^2 3p^6$  Look carefully at $1s^2 2s^2 2p^6 3s^2 3p^6$ – there may be a mistake
	(b)	(i)	4	Voltmeter must be shown <b>AND</b> salt bridge must be labelled <b>ALLOW</b> small gaps in circuit  <b>ALLOW</b> half cells drawn either way around <b>IGNORE</b> 2 before I <sup>-</sup> (aq) <b>DO NOT ALLOW</b> I <sub>2</sub> (g) <b>OR</b> I <sub>2</sub> (s) <b>OR</b> I <sub>2</sub> (l)  <b>ALL</b> conditions required <b>BUT ALLOW</b> 1 mol dm <sup>-3</sup> /1M if omitted here but shown for just one solution in diagram Look on diagram in addition to answer lines  <b>IGNORE</b> pressure <i>Not relevant for this cell</i>  <b>DO NOT ALLOW</b> 1 mol for concentration
	(b)	(ii)	1	<b>IGNORE</b> sign
	(c)	(i)	1	<b>ALLOW</b> multiples <b>IGNORE</b> state symbols, even if wrong



H032/01

Mark Scheme

June 2017

Question		Answer	Marks	Guidance
(c)	(ii)	<p><b>Equations</b></p> $3\text{Zn(s)} + \text{Cr}_2\text{O}_7^{2-}(\text{aq}) + 14\text{H}^+(\text{aq}) \rightarrow 3\text{Zn}^{2+}(\text{aq}) + 2\text{Cr}^{3+}(\text{aq}) + 7\text{H}_2\text{O(l)}$ <p>✓</p> $\text{Zn(s)} + 2\text{Cr}^{3+}(\text{aq}) \rightarrow \text{Zn}^{2+}(\text{aq}) + 2\text{Cr}^{2+}(\text{aq}) \quad \checkmark$ <p><b>Comparison of <math>E</math> values (seen once)</b></p> <p><math>E</math> of Zn is more negative/less positive than <math>E</math> of <math>\text{Cr}_2\text{O}_7^{2-}</math></p> <p><b>OR</b></p> <p><math>E</math> of Zn is more negative/less positive than <math>E</math> of <math>\text{Cr}^{3+}</math></p> <p>✓</p> <p><b>Equilibrium shift related to <math>E</math> values</b></p> <p>More negative/less positive <b>OR</b> Zn system shifts left</p> <p><b>OR</b></p> <p>Less negative/more positive <math>\text{Cr}_2\text{O}_7^{2-}</math> system shifts right <b>OR</b> Less negative/more positive <math>\text{Cr}^{3+}</math> system shifts right ✓</p>	4	<p><b>ALLOW</b> multiples <b>IGNORE</b> state symbols, even if wrong</p> <p><b>ALLOW</b> <math>E_{\text{cell}}</math> is (+) 2.09V for Zn/<math>\text{Cr}_2\text{O}_7^{2-}</math> cell <b>OR</b> <b>ALLOW</b> <math>E_{\text{cell}}</math> is (+) 0.34V for Zn/<math>\text{Cr}^{3+}</math> cell <b>IGNORE</b> 'lower/higher'</p> <p>For 'shifts left': <b>ALLOW</b> '(Zn) is oxidised' <b>OR</b> 'electrons are lost (from Zn)'</p> <p>For 'shifts right', <b>ALLOW</b> '(Cr) is reduced' <b>OR</b> 'electrons are gained'</p>

H032/01

Mark Scheme

June 2017

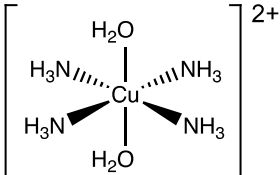
Question	Answer	Marks	Guidance																					
(d)	<p><i>Please refer to the marking instructions on page 5 of this mark scheme for guidance on how to mark this question.</i></p> <p><b>Level 3 (5–6 marks)</b> All three reactions are covered in detail with <b>C, D, E</b> and <b>F</b> identified with clear explanations.</p> <p><i>There is a well-developed line of reasoning which is clear and logically structured with clear chemical communication and few omissions. The information presented is relevant and substantiated.</i></p> <p><b>Level 2 (3–4 marks)</b> All three reactions are covered but explanations may be incomplete <b>OR</b> Two reactions are explained in detail.</p> <p><i>There is an attempt at a logical structure with a line of reasoning. The information is relevant e.g. formulae may contain missing brackets or numbers and supported by some evidence.</i></p> <p><b>Level 1 (1–2 marks)</b> Make two simple explanations from any one reaction. <b>OR</b> Makes one simple explanation from each of two reactions</p> <p><i>There is an attempt at a logical structure with a line of reasoning The information is in the most part relevant.</i></p> <p><b>0 marks</b> No response worthy of credit.</p>	6	<p><b>Indicative scientific points may include:</b></p> <p><b>REACTION 1 (CuSO<sub>4</sub>/NH<sub>3</sub>)</b> <b>Product</b> <b>C</b> : [Cu(NH<sub>3</sub>)<sub>4</sub>(H<sub>2</sub>O)<sub>2</sub>]<sup>2+</sup> <b>Equation</b> [Cu(H<sub>2</sub>O)<sub>6</sub>]<sup>2+</sup> + 4NH<sub>3</sub> → [Cu(NH<sub>3</sub>)<sub>4</sub>(H<sub>2</sub>O)<sub>2</sub>]<sup>2+</sup> + 4H<sub>2</sub>O <b>Structure of trans stereoisomer</b></p>  <p>Correct connectivity</p> <p><b>REACTION 2 (Cu<sub>2</sub>O/H<sub>2</sub>SO<sub>4</sub>)</b> <b>Products</b> <b>D</b> : CuSO<sub>4</sub> <b>OR</b> [Cu(H<sub>2</sub>O)<sub>6</sub>]<sup>2+</sup> <b>E</b>: Cu <b>Equation</b> Cu<sub>2</sub>O + H<sub>2</sub>SO<sub>4</sub> → CuSO<sub>4</sub> + Cu + H<sub>2</sub>O <b>Oxidation numbers</b> Cu(+1) → Cu(+2) + Cu(0)</p> <p><b>REACTION 3 (CuO/HNO<sub>3</sub>)</b> <b>Equation</b> CuO + 2HNO<sub>3</sub> → Cu(NO<sub>3</sub>)<sub>2</sub> + H<sub>2</sub>O <b>Molar ratios</b></p> <table style="margin-left: auto; margin-right: auto;"> <tr> <td style="text-align: center;">Cu</td> <td style="text-align: center;">:</td> <td style="text-align: center;">H</td> <td style="text-align: center;">:</td> <td style="text-align: center;">N</td> <td style="text-align: center;">:</td> <td style="text-align: center;">O</td> </tr> <tr> <td style="text-align: center;">= 26.29</td> <td style="text-align: center;">:</td> <td style="text-align: center;">2.49</td> <td style="text-align: center;">:</td> <td style="text-align: center;">11.59</td> <td style="text-align: center;">:</td> <td style="text-align: center;">59.63</td> </tr> <tr> <td style="text-align: center;">63.5</td> <td style="text-align: center;">:</td> <td style="text-align: center;">1.0</td> <td style="text-align: center;">:</td> <td style="text-align: center;">14.0</td> <td style="text-align: center;">:</td> <td style="text-align: center;">16.0</td> </tr> </table> <p><b>Formula of F</b> CuH<sub>6</sub>N<sub>2</sub>O<sub>9</sub> <b>F</b>: Cu(NO<sub>3</sub>)<sub>2</sub>•3H<sub>2</sub>O (<b>OR</b> Cu(NO<sub>3</sub>)<sub>2</sub>(H<sub>2</sub>O)<sub>3</sub>)</p>	Cu	:	H	:	N	:	O	= 26.29	:	2.49	:	11.59	:	59.63	63.5	:	1.0	:	14.0	:	16.0
Cu	:	H	:	N	:	O																		
= 26.29	:	2.49	:	11.59	:	59.63																		
63.5	:	1.0	:	14.0	:	16.0																		

H032/01

Mark Scheme

June 2017

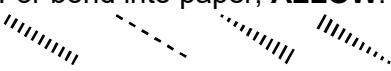
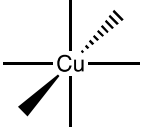
Question			Answer	Marks	Guidance
					<p>-----</p> <p><b>Further guidance on use of wedges</b></p> <ul style="list-style-type: none"> <li>• Must contain 2 'out wedges', 2 'in wedges' and 2 lines in plane of paper <b>OR</b> 4 lines, 1 'out wedge' and 1 'in wedge':</li> <li>• For bond into paper, <b>ALLOW</b>:  </li> <li>• <b>ALLOW</b> following geometry:  </li> </ul>
			<b>Total</b>	<b>18</b>	

**OCR (Oxford Cambridge and RSA Examinations)**  
**The Triangle Building**  
**Shaftesbury Road**  
**Cambridge**  
**CB2 8EA**

**OCR Customer Contact Centre**

**Education and Learning**

Telephone: 01223 553998

Facsimile: 01223 552627

Email: [general.qualifications@ocr.org.uk](mailto:general.qualifications@ocr.org.uk)

[www.ocr.org.uk](http://www.ocr.org.uk)

For staff training purposes and as part of our quality assurance programme your call may be recorded or monitored

**Oxford Cambridge and RSA Examinations**  
is a Company Limited by Guarantee  
Registered in England  
Registered Office; The Triangle Building, Shaftesbury Road, Cambridge, CB2 8EA  
Registered Company Number: 3484466  
OCR is an exempt Charity

**OCR (Oxford Cambridge and RSA Examinations)**  
Head office  
Telephone: 01223 552552  
Facsimile: 01223 552553

© OCR 2018

 **Cambridge  
Assessment**

