

Cambridge
International
AS & A Level

Cambridge International Examinations
Cambridge International Advanced Subsidiary and Advanced Level

BIOLOGY

9700/13

Paper 1 Multiple Choice

October/November 2014

1 hour

Additional Materials: Multiple Choice Answer Sheet
 Soft clean eraser
 Soft pencil (type B or HB is recommended)



READ THESE INSTRUCTIONS FIRST

Write in soft pencil.

Do not use staples, paper clips, glue or correction fluid.

Write your name, Centre number and candidate number on the Answer Sheet in the spaces provided unless this has been done for you.

DO NOT WRITE IN ANY BARCODES.

There are **forty** questions on this paper. Answer **all** questions. For each question there are four possible answers **A, B, C** and **D**.

Choose the **one** you consider correct and record your choice in **soft pencil** on the separate Answer Sheet.

Read the instructions on the Answer Sheet very carefully.

Each correct answer will score one mark. A mark will not be deducted for a wrong answer.

Any rough working should be done in this booklet.

Electronic calculators may be used.

This document consists of **18** printed pages and **2** blank pages.

2

- 1 The eyepiece of a microscope is fitted with an eyepiece graticule and a stage micrometer scale is placed on the microscope.

Which statements about the stage micrometer scale are correct?

- 1 It allows you to measure the actual length of cells.
- 2 It allows you to calibrate the eyepiece graticule.
- 3 It changes in size as the objective lens changes from $\times 10$ to $\times 40$.

A 1, 2 and 3 **B** 2 and 3 only **C** 1 only **D** 2 only

- 2 Density gradient centrifuges are used to separate cell structures by their relative density. Larger cell structures have greater density and sink further down the centrifuge tube.

What is the correct order of the cell structures, starting from the top of the centrifuge tube?

- A** chloroplasts \rightarrow nuclei \rightarrow mitochondria \rightarrow ribosomes
- B** nuclei \rightarrow chloroplasts \rightarrow mitochondria \rightarrow ribosomes
- C** ribosomes \rightarrow chloroplasts \rightarrow mitochondria \rightarrow nuclei
- D** ribosomes \rightarrow mitochondria \rightarrow chloroplasts \rightarrow nuclei

- 3 Red blood cells have a diameter of 7000 nm.

Pancreatic cells have a diameter of diameter 35 μm .

What is correct about the relative sizes of these cells?

- A** The red blood cells are 5 times larger.
- B** The red blood cells are 50 times larger.
- C** The red blood cells are 5 times smaller.
- D** The red blood cells are 50 times smaller.

3

- 4 Which cell structure shown in the electronmicrograph is the site of protein modification and packaging?

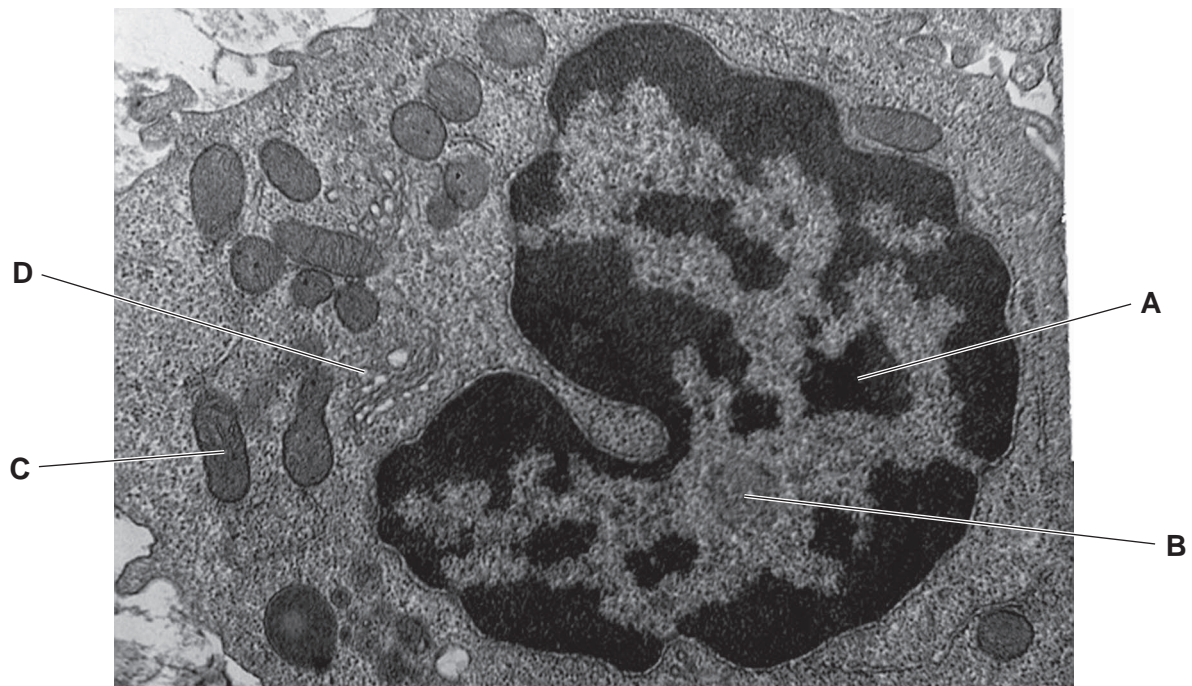

- 5 The diagram shows some similarities between typical prokaryotes, chloroplasts and mitochondria.

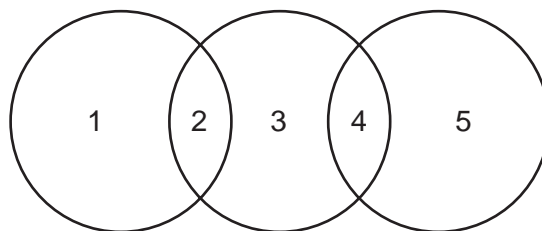

Which is correct?

	1	2	3	4	5
A	chloroplasts	circular DNA and 70S ribosomes	mitochondria	circular DNA and 70S ribosomes	prokaryotes
B	chloroplasts	circular DNA and 80S ribosomes	prokaryotes	circular DNA and 80S ribosomes	mitochondria
C	mitochondria	linear DNA and 70S ribosomes	chloroplasts	linear DNA and 70S ribosomes	prokaryotes
D	mitochondria	linear DNA and 80S ribosomes	prokaryotes	linear DNA and 80S ribosomes	chloroplasts

- 6 Samples of a mixture of biological molecules were tested using Benedict's reagent, biuret solution and ethanol. After testing, the solutions were blue with Benedict's reagent, purple with biuret and cloudy with ethanol.

Which molecules could the mixture contain?

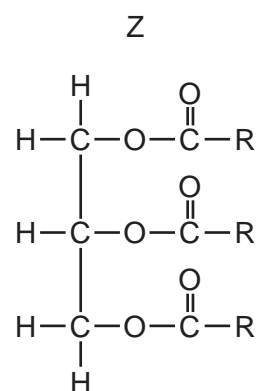
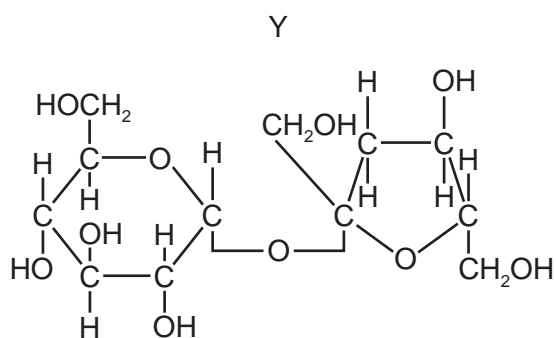
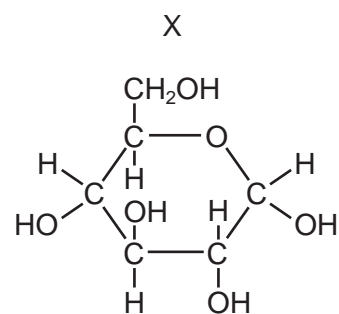
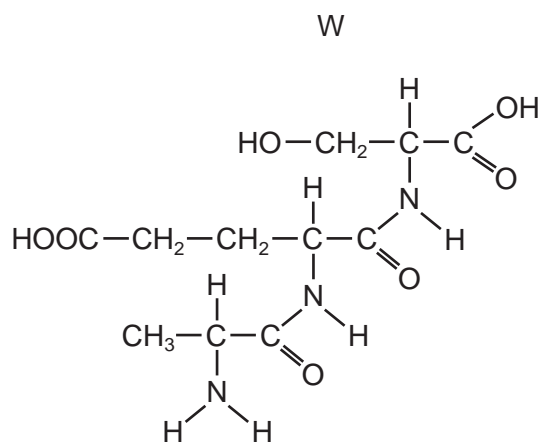

- A** W, X and Y
B W, X and Z
C W, Y and Z
D X, Y and Z

7 The diagram shows a section of a polysaccharide.

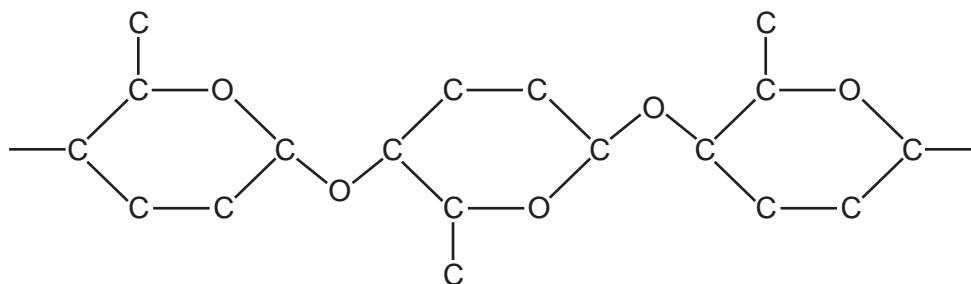

In which polysaccharide(s) could this section be found?

- 1 amylose
- 2 cellulose
- 3 glycogen

A 1 only **B** 2 only **C** 1 and 3 **D** 2 and 3

8 Chromatography is a technique used to separate molecules by their solubility. The diagram shows one apparatus used for this technique.

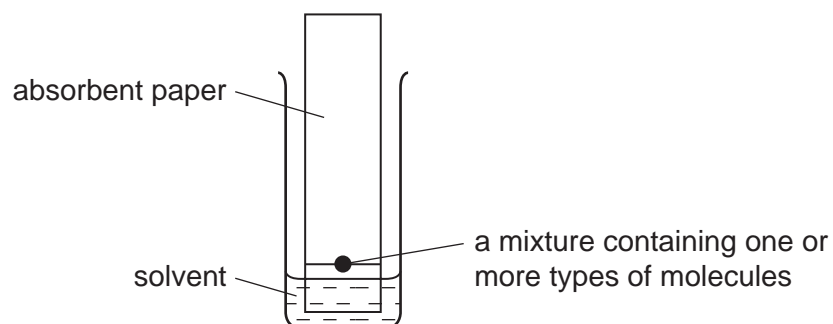

As the solvent rises up the paper, the molecules with the greatest solubility in the solvent travel a fixed distance up the paper. When the solvent reaches the top of the paper, the paper is removed, dried and sprayed with a dye. The different molecules appear as coloured spots.

Chromatography was carried out on four different carbohydrates; sucrose, cellulose, the products of hydrolysis of sucrose and the products of hydrolysis of cellulose.

Which diagram shows the presence of the products of sucrose digestion?

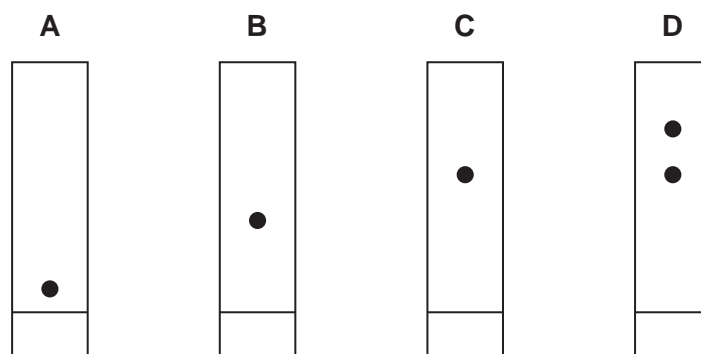

- 9 In all lipid molecules, where are double bonds located?
- A between fatty acids and glycerol
 - B within fatty acids and within glycerol
 - C within fatty acids only
 - D within glycerol only
- 10 Which of the following terms can be used to describe the secondary structure of a protein?
- 1 dipeptide
 - 2 specific order of amino acids
 - 3 α -helix
 - 4 fibrous structure
 - 5 β -pleated sheet
- A 1, 3, 4 and 5
 - B 1, 2 and 4
 - C 2 and 4 only
 - D 3 and 5 only
- 11 Why is haemoglobin stated to have a quaternary structure?
- A It has four haem groups.
 - B It has two or more polypeptide chains.
 - C It is coiled into a precise shape.
 - D It is held together by four types of bonds.

- 12 A quantity of an enzyme was added to a quantity of its substrate. The graphs show the changes in concentration of the enzyme, the substrate, the enzyme-substrate complex and the product over time.

Which graph shows the change in the concentration of the enzyme-substrate complex?

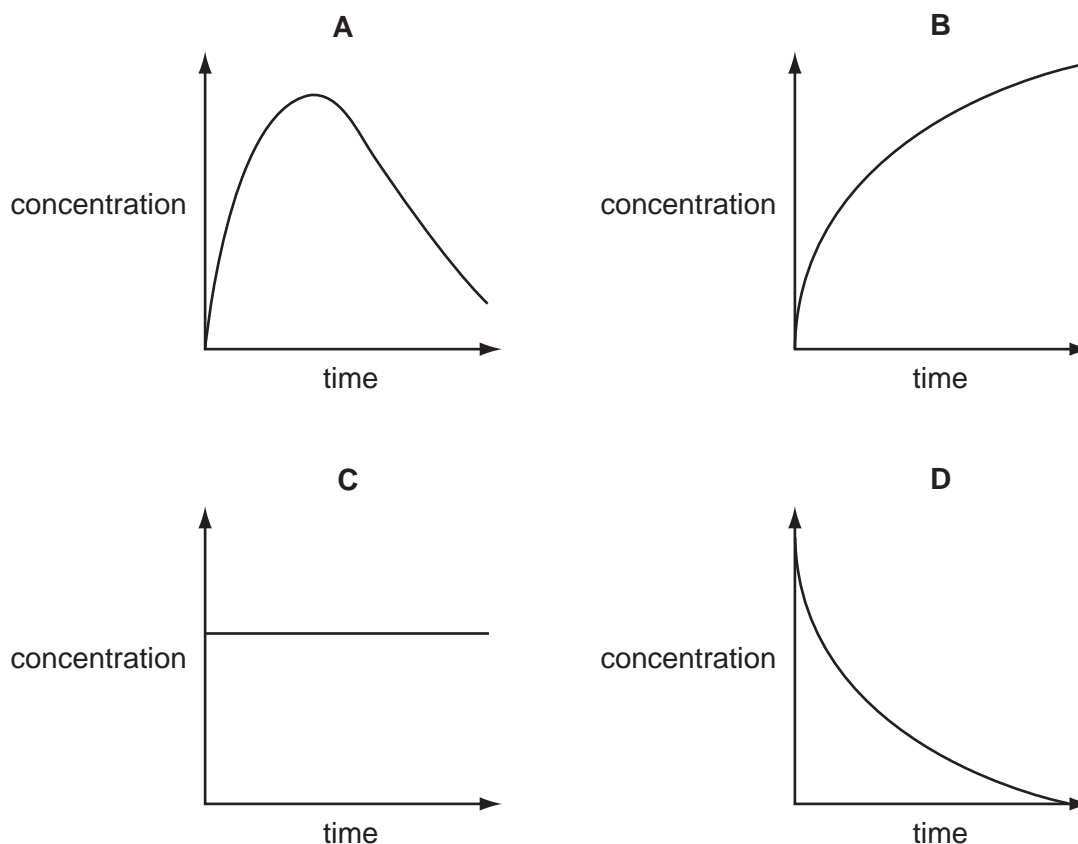

- 13 Which is correct for a competitive inhibitor of an enzyme?

A	inhibitor binds to a site on the enzyme other than the active site	the substrate concentration has no effect on the level of inhibition
B	inhibitor binds to the active site of the enzyme	increasing the substrate concentration decreases the effect of the inhibitor
C	inhibitor binds to the active site of the enzyme	the substrate concentration has no effect on the level of inhibition
D	inhibitor binds to the enzyme-substrate complex	increasing the substrate concentration decreases the effect of the inhibitor

- 14 Which two substances maintain the fluidity of the cell membranes?

- A** cholesterol and glycolipid
- B** glycolipid and glycoprotein
- C** glycoprotein and phospholipid
- D** phospholipid and cholesterol

- 15** Membrane proteins are called 'peripheral' if they are temporarily attached to the membrane or 'integral' if they are permanently attached to the membrane.

Integral proteins are described as 'intrinsic' if they extend across the whole bilayer and 'extrinsic' if they are found only in one side of the bilayer.

How would you describe a channel protein?

- A** integral extrinsic
B integral intrinsic
C peripheral extrinsic
D peripheral intrinsic
- 16** The diagram shows apparatus set up to investigate the effect of changing the concentration of glucose in the surrounding solution on the movement of molecules through a selectively permeable membrane (Visking tubing) in 15 minutes.

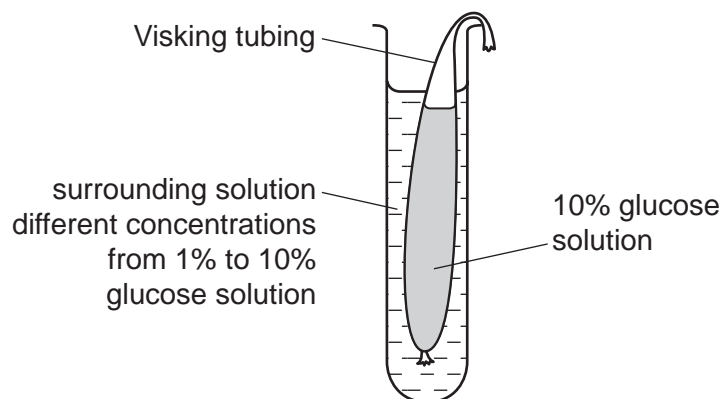

As the concentration of glucose solution in the surrounding solution increases, which statements are correct?

- 1 Net diffusion of water increases.
 - 2 Glucose molecules reach an equilibrium quicker.
 - 3 There is less change in the volume of surrounding solution.
 - 4 Net diffusion of glucose increases.
- A** 1, 2, 3 and 4
B 1, 2 and 4 only
C 1 and 3 only
D 2 and 3 only

17 Which is always true of cytokinesis?

- 1 Cell structures replicate.
- 2 Cell structures are divided between two cells.
- 3 Nuclear envelope reforms.

A 1, 2 and 3 **B** 1 and 3 only **C** 2 only **D** 3 only

18 The statements are about genes and proteins, involved in breast cancer.

- The protein coded by the *BRAC1* gene inhibits the growth of breast cancer cells.
- The protein coded by the *p53* gene suppresses tumours.

Which combination of genes is most likely to result in breast cancer?

	gene	
	<i>BRAC1</i>	<i>p53</i>
A	<i>x</i>	<i>x</i>
B	<i>x</i>	✓
C	✓	<i>x</i>
D	✓	✓

key

✓ = normal active gene

x = mutated gene

19 Which structural feature of the DNA molecule varies?

- A** the arrangement of the sugar-phosphate groups
- B** the double helical arrangement
- C** the number of hydrogen bonds between base pairs
- D** the pairing of the purines with pyrimidines

20 DNA is said to replicate in a semi-conservative way.

Results of Meselson and Stahl's experiments gave overwhelming support to this theory. They used *E. coli* which has a generation time of 50 minutes.

Here are the stages occurring in their experiment but they are in the wrong order. ^{14}N DNA contains the 'light' isotope of nitrogen. ^{15}N DNA contains the 'heavy' isotope.

- P All bacteria contain ^{15}N DNA.
- Q All bacteria contain hybrid DNA (^{15}N DNA and ^{14}N DNA).
- R Bacteria contain either all ^{14}N DNA or hybrid DNA.
- S Bacteria grown in a ^{15}N medium for many generations.
- T Bacteria transferred to a ^{14}N medium and sampled every 50 minutes.

Which sequence of letters shows the correct order of the stages in the experiment?

- A P → S → T → R → Q
- B P → T → S → Q → R
- C S → P → T → Q → R
- D S → T → P → R → Q

21 Which molecules are involved in transcription and which molecules are involved in translation?

	transcription	translation
A	DNA and mRNA	mRNA and tRNA
B	DNA and tRNA	mRNA and amino acids
C	mRNA and amino acids	DNA and mRNA
D	tRNA and mRNA	amino acids and DNA

22 Which processes occur in the vascular tissue in leaves and in roots?

	in leaves	in roots
A	sucrose enters phloem and is polymerised to starch	water passes from phloem to xylem by osmosis
B	sucrose enters phloem by active transport and the water potential becomes more negative	sucrose is used or polymerised and the water potential becomes less negative
C	water passes from phloem to xylem by osmosis, making the phloem water potential less negative	active transport of water into the xylem makes the water potential more negative
D	water passes out of xylem and phloem and is lost through transpiration	active transport of ions into the xylem makes the water potential less negative

23 The diagram shows the water potential (Ψ) in some plant cells and in their environment.

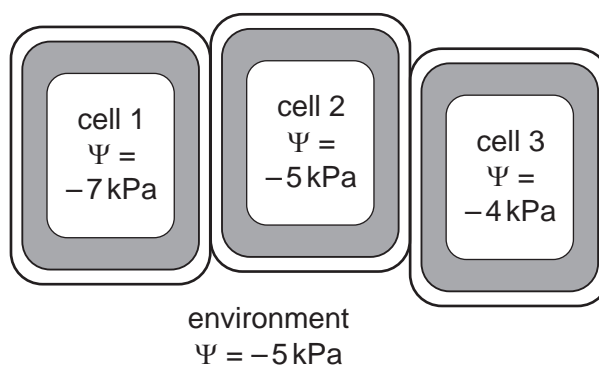

Which statements are correct?

- 1 Water moves into and out of all three cells.
- 2 There is a net movement of water into cell 1.
- 3 There is no movement of water from the environment to cell 2.
- 4 Water moves out of cell 1 so it becomes plasmolysed.

A 1 and 2 **B** 1 and 3 **C** 3 and 4 **D** 4 only

24 A region of a plant containing the vascular tissue is treated with a metabolic poison.

How will this treatment affect the transport between roots and leaves via xylem and phloem?

	xylem	phloem
A	✓	✓
B	✓	x
C	x	✓
D	x	x

key

✓ = transport continues

x = transport stops

25 A group of students were asked to look at the photomicrograph of a cross-section of unfamiliar material and make observations.

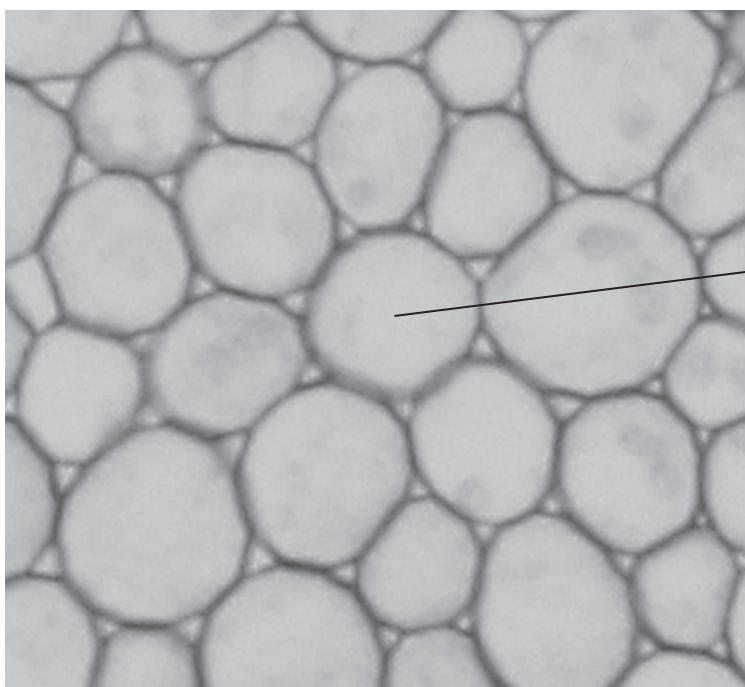

They described X as

- 1 circular
- 2 a hollow tube
- 3 a spherical structure

Which description(s) are correct?

- A** 1, 2 and 3 **B** 1 and 2 only **C** 1 only **D** 3 only

26 What is correct for tissue fluid?

	phagocytes	platelets	protein concentration compared to blood plasma
A	✓	✓	higher
B	x	x	higher
C	✓	x	lower
D	x	✓	lower

key

✓ = present

x = absent

27 The graph shows the dissociation curves for adult haemoglobin at two different (unidentified) concentrations of carbon dioxide.

Which point represents the oxygen concentration in red blood cells as they leave a resting muscle?

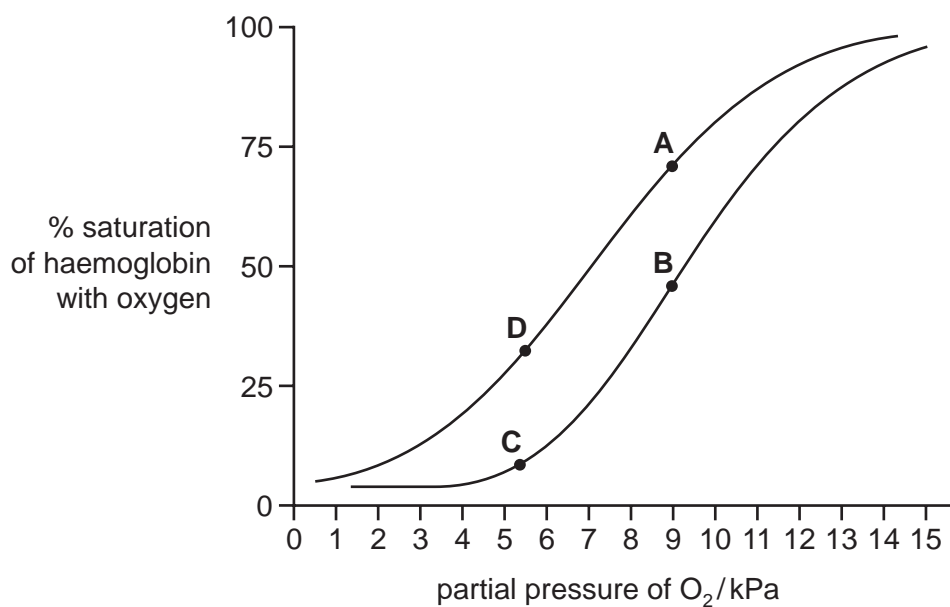

- 28 The diagram shows the pressure changes in various structures of the left side of the heart during the cardiac cycle.

Which letter shows when the ventricle is empty of blood?

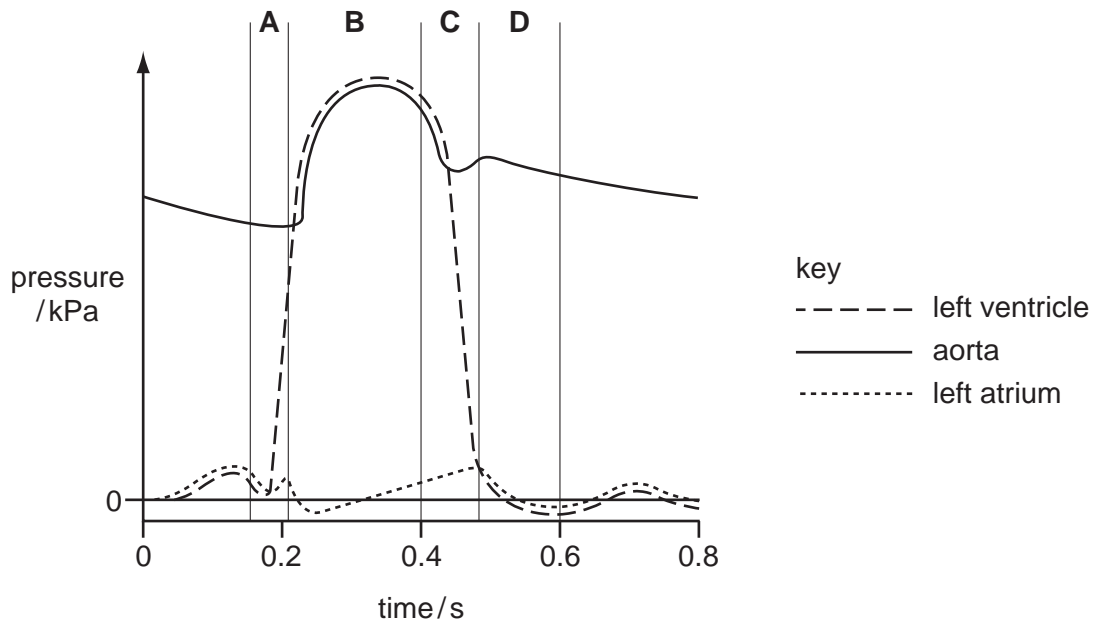

- 29 Which statement concerning events that occur in the heart is correct?
- A** As the wave of excitation passes through the atrioventricular node there is a time delay before it passes down the Purkyne tissue to the ventricles.
- B** Movement of blood into the ventricles following atrial contraction causes the ventricular blood pressure to rise above the blood pressure in the atria, closing the atrioventricular valve.
- C** The band of non-conducting tissue between the atria and ventricles causes the wave of excitation to pass through the Purkyne tissue to reach the atrioventricular node.
- D** The sinoatrial node in the left atrium, sends out a wave of excitation that spreads across the walls of the atria, resulting in the movement of blood from the atria into the ventricles.
- 30 Which row correctly shows the areas of the gas exchange system that contain cartilage, ciliated epithelium, goblet cells and smooth muscle?

	cartilage	ciliated epithelium	goblet cells	smooth muscle
A	bronchiole, trachea	bronchiole, trachea	bronchus, trachea	bronchiole, trachea
B	bronchus, trachea	bronchiole, bronchus	bronchus, trachea	bronchiole, trachea
C	bronchiole, trachea	bronchus, trachea	bronchiole, bronchus	bronchiole, bronchus, trachea
D	bronchus, trachea	bronchiole, bronchus, trachea	bronchus, trachea	bronchiole, bronchus, trachea

- 31 Which observation would indicate a difference between the structure of the gas exchange system of a cigarette smoker and a non-smoker?
- A absence of ciliated epithelium
 - B decrease in elastic fibres
 - C enlargement of goblet cells
 - D increase in smooth muscle

- 32 Asthma is a lung disease triggered by the inhalation of an allergen such as pollen or dust. The allergen triggers;
- bronchi and bronchioles to become inflamed and narrow
 - goblet cells lining these airways to secrete excess mucus.

Which effects will these responses have on the gaseous exchange system of a person with asthma?

- 1 decrease the diffusion gradient for oxygen in the lungs
- 2 increase the diffusion distance from the alveoli into the blood
- 3 increase the risk of developing a lung infection

- A 1 and 2 B 1 and 3 C 2 and 3 D 3 only

- 33 A person who returns home after a visit to a foreign country starts to have fevers at regular intervals. Blood tests taken between the fevers and during the fevers show a decrease in the number of red blood cells (anaemia).

Which disease does this person have?

- A cholera
- B HIV/AIDS
- C malaria
- D TB

- 34 Why do people in refugee camps have a high risk of being infected by cholera?
- A Drinking water is likely to be contaminated with sewage.
 - B People live in close contact, increasing the risk of droplet infection.
 - C There is a shortage of antibiotics.
 - D There is a shortage of food and water.

35 Which statements explain why cholera has **not** been eradicated by vaccination?

- 1 Cholera is caused by the bacterium *Vibrio cholerae*.
- 2 Many people can have the disease, but show no symptoms.
- 3 People are mobile due to global trade and tourism.
- 4 The cholera pathogens target cells in the small intestine.

- A** 1, 2, 3 and 4
B 1 and 2 only
C 2 and 4 only
D 3 and 4 only

36 Cells which divide and give rise to macrophages are called stem cells.

Where in the body do these stem cells divide?

- A** blood plasma
B bone marrow
C lymph nodes
D tissue fluid

37 Which type of immunity occurs following infection by a pathogen?

	natural	artificial
active	A	B
passive	C	D

38 The diagram shows part of the nitrogen cycle.

Which process is carried out by denitrifying bacteria?

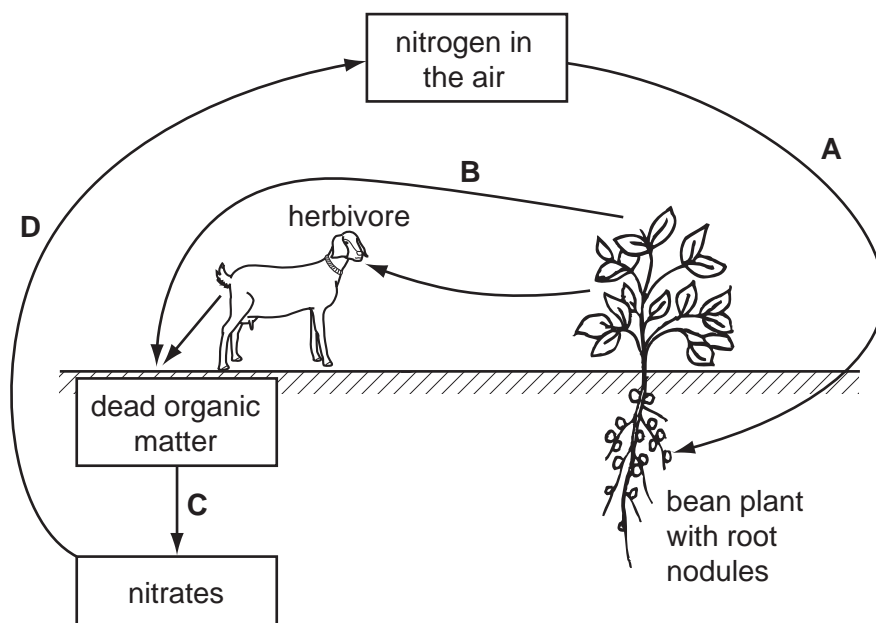

39 The graph shows the annual changes of the following factors in a lake.

- intensity of light per day
- numbers of producers
- numbers of primary consumers
- quantity of nutrients

Which curve represents the numbers of primary consumers?

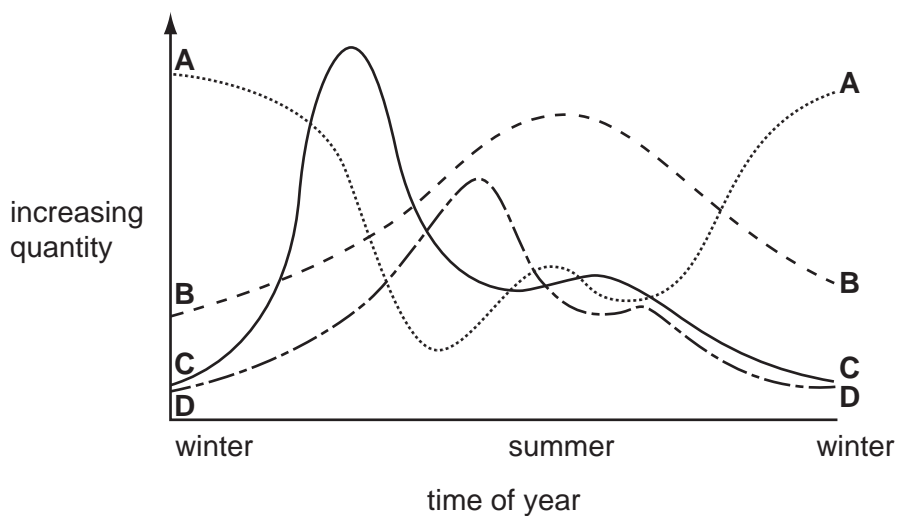

- 40 In a food chain, which link involves the least efficient energy transfer?
- A Corn traps sunlight during photosynthesis.
 - B Mice eat the grain from corn.
 - C Mongooses feed on snakes.
 - D Snakes feed on mice.

BLANK PAGE

BLANK PAGE

Copyright Acknowledgements:

Question 4 © <http://remf.dartmouth.edu/images/mammalianLungTEM/source/1.html>; 10 January 2012.

Permission to reproduce items where third-party owned material protected by copyright is included has been sought and cleared where possible. Every reasonable effort has been made by the publisher (UCLES) to trace copyright holders, but if any items requiring clearance have unwittingly been included, the publisher will be pleased to make amends at the earliest possible opportunity.

Cambridge International Examinations is part of the Cambridge Assessment Group. Cambridge Assessment is the brand name of University of Cambridge Local Examinations Syndicate (UCLES), which is itself a department of the University of Cambridge.