



Chemical Bonding in Biological Molecules

The contents of this Factsheet are directed towards AS level candidates. By studying this factsheet students should gain a knowledge and understanding of:

- glycosidic bonds in carbohydrate structure.
- peptide bonds in polypeptide structure.
- ester bonds in lipid structure.
- hydrogen bonding.
- sulphur bonding.
- phosphate bonding.

Introduction

Glycosidic, peptide and ester bonds are formed by a process called **condensation**. This is the joining of molecules by the removal of water and involves removing a hydroxide group from one of the molecules and a hydrogen from the other molecule. This type of reaction is important in synthetic processes. The reverse process, involved in digestion, is **hydrolysis** which is the splitting of molecules by the addition of water.

Glycosidic bonds

These are the bonds which join single sugars (monosaccharides) together to form double sugars (disaccharides) and multiple sugars (polysaccharides). The formation of a glycosidic link is shown in Fig 1.

Fig 1. Formation of a glycosidic link

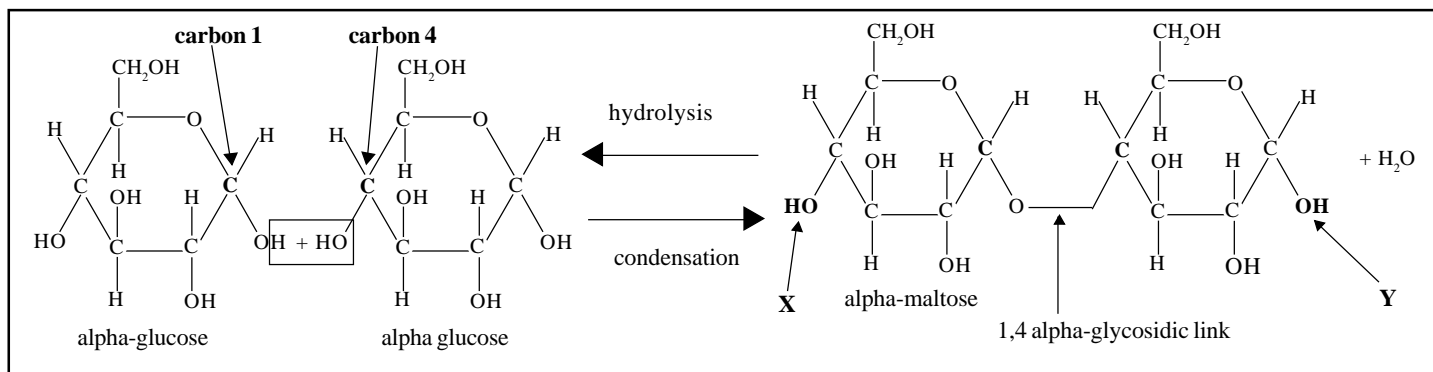

By adding more alpha-glucose molecules on at positions X and Y the backbone molecules of starch(alpha-amylase) and glycogen may be built up. Alpha-amylase can be between 300 and 3000 alpha-glucoses long. The other component of starch is amylopectin. This is similar to alpha-amylase but is branched about every twentieth glucose by a **1,6 glycosidic branch link**. Glycogen has a structure similar to amylopectin but branches more frequently at about every twelfth glucose.

The reactive –OH group on carbon 1, labelled Y, is a reducing group and so gives the glucose reducing properties. (the power to donate hydrogen or electrons to other substances). In alpha-glucose this group is below the ring structure and during polymerisation forms **1,4 alpha-glycosidic bonds**. These can be hydrolysed by alpha-amylase enzymes, for example, salivary and pancreatic amylases in mammals and diastase in seeds, and so molecules such as starch and glycogen can be digested to maltose and then by maltase enzyme to glucose. The structures of alpha-amylase and amylopectin are shown in Fig 2.

Exam Hint - Candidates will be expected to recognise and name molecules and bonds but will not be expected to write down structural formulae from memory. Candidates may be asked direct questions about types of bonds, or may need to refer to the different bond types in essay answers.

Fig 2. Structure of alpha-amylase and amylopectin

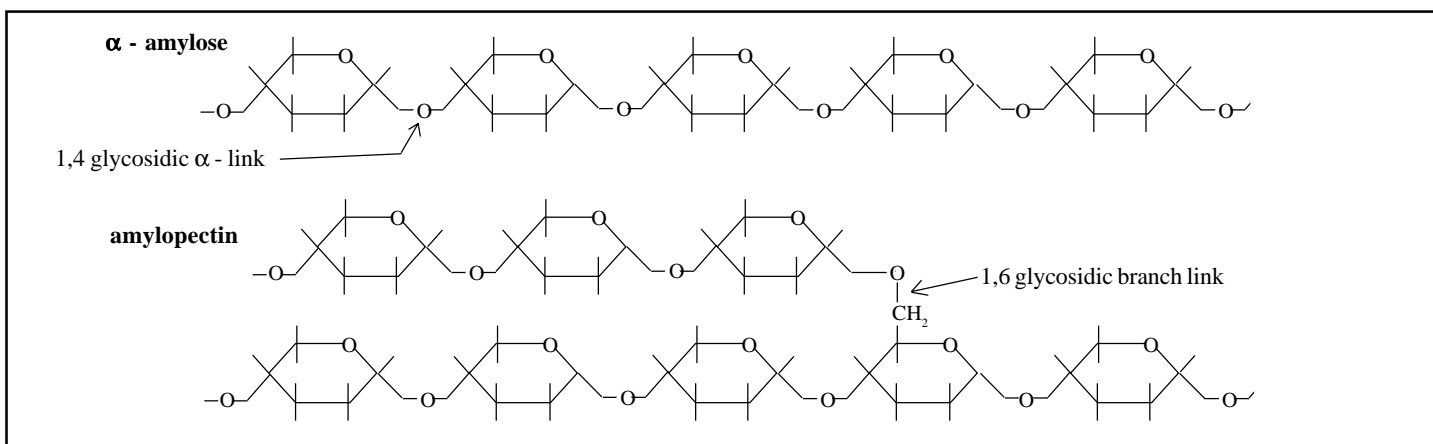

Enzymes for breaking down the 1,6 glycosidic branch links are not present in most animals and so amylopectin (and glycogen) can only be digested by amylases down to the branch points. This leaves an indigestible residue of amylopectin, which is called dextrin. Cooking will hydrolyse the 1,6 glycosidic links and thus cooked starch can be completely digested.

In beta-glucose the reducing -OH group lies above the ring structure and when glycosidic bonds form they are **1,4 beta-glycosidic bonds (links)**. These are found in the structural compound, cellulose. The formation of a beta-link is shown in Fig 3.

Fig 3. Formation of a 1,4 beta-glycosidic link

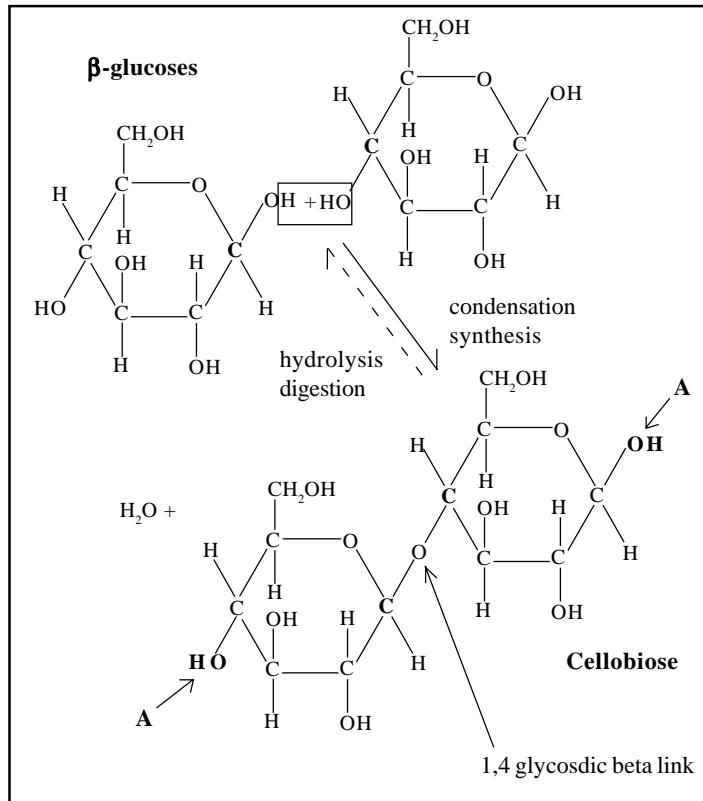

More beta glucoses can be added, on by condensation, to the disaccharide cellobiose at points A to build up a long unbranched cellulose molecule. Cellulose molecules run together in parallel fashion to form cellulose fibrils. Within a fibril the adjacent cellulose molecules cross link by **hydrogen bonds**. (Hydrogen bonds are described below). Individually such bonds are weak but their presence in large numbers gives strength which makes cellulose a good structural material in plant cell walls.

Very few animals possess cellulase enzymes capable of hydrolysing beta glycosidic links and so cellulose is usually indigestible. Many fungi and bacteria possess cellulases and are important in breaking cellulose down in rotting vegetation in the soil. The microbes in the rumens of cow and sheep also possess cellulases and so can break down the cellulose in the grass that these animals eat.

Formation of peptide bonds

Peptide bonds are formed by condensation between the acid group of one amino acid and the amine group of another amino acid. They enable amino acids to be joined into long chains called polypeptides. Fig 4. shows the formation of a dipeptide from two amino acids.

Fig 4. Formation of a peptide bond

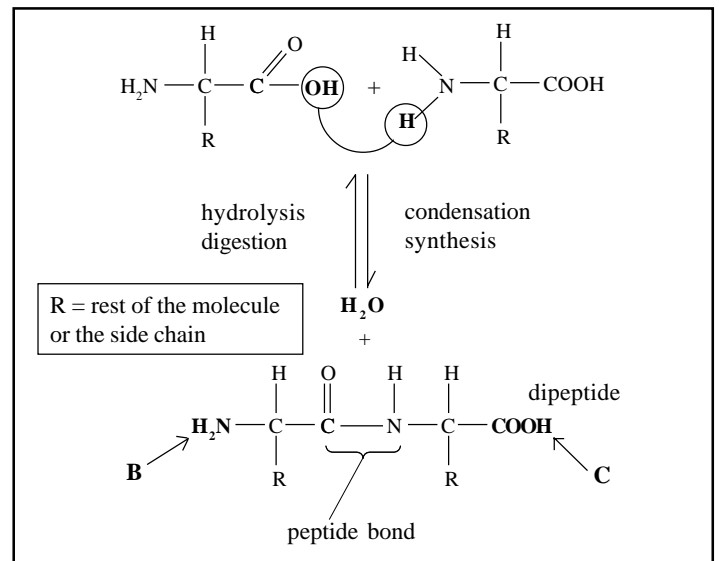

More amino acids can attach by condensation onto the amine group at B and the acid group at C so that a long chain of amino acids (a polypeptide) can be assembled. Polypeptides may be folded and cross-bonded into particular three dimensional shapes and assembled together into proteins. This involves **hydrogen** and **sulphur** bonds (described below) rather than peptide bonds. **Ionic attractions** may also be important in stabilising the three dimensional shapes of proteins. This is illustrated in Fig 5.

Fig 5. Ionic association (attraction) between two parts of a polypeptide chain.

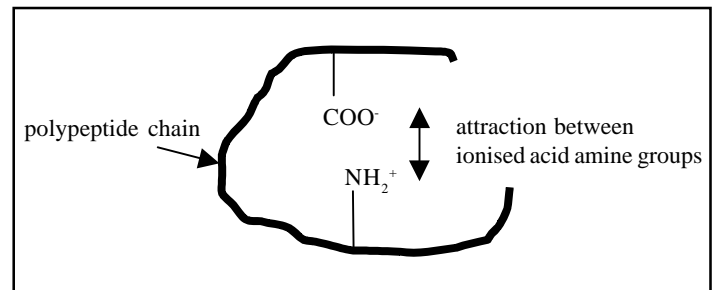

Formation of ester bonds in lipid structure

An ester bond is formed by condensation between an acid and an alcohol. The main alcohol involved in lipid structure is glycerol (which has 3 alcohol or -OH groups) and the acids involved are fatty acids. Fig 6 shows the formation of a triglyceride.

Fig 6. Formation of a triglyceride

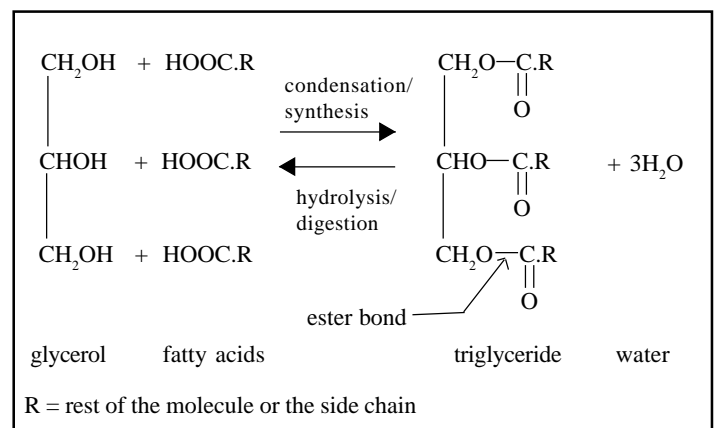

Hydrogen bonding

Water consists of two hydrogen atoms, each of which shares an electron with the single oxygen atom. These shared electrons (negative) lie closer to the oxygen than to the hydrogens (positive protons) and so the molecule becomes a charged dipole, with two partial positive charges at one end and a partial negative charge at the other end. This is shown in Fig 7.

Fig 7 . The water molecule

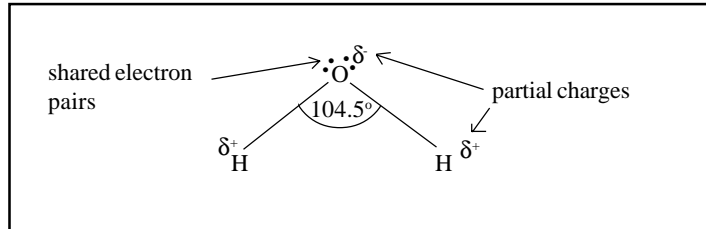

Because of these charges the hydrogen atoms of one water molecule are attracted to the oxygen atoms of adjacent water molecules. These attractions are called hydrogen bonds and are shown in Fig 8.

Fig 8. Hydrogen bonding between water molecules.

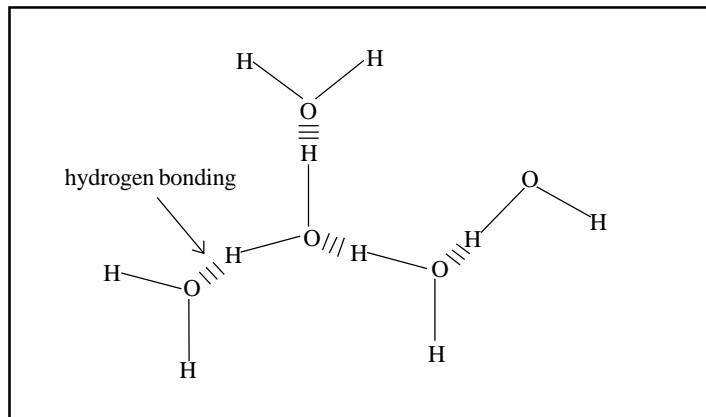

Hydrogen bonds occur between:

- parallel cellulose molecules holding them together in fibrils,
- opposite purine and pyrimidine bases holding DNA structure together
- polypeptide chains holding shape and protein structure together.

Fig 9 shows hydrogen bonds between nearby peptide bonds between two polypeptides.

Fig 9. Hydrogen bonding in polypeptides

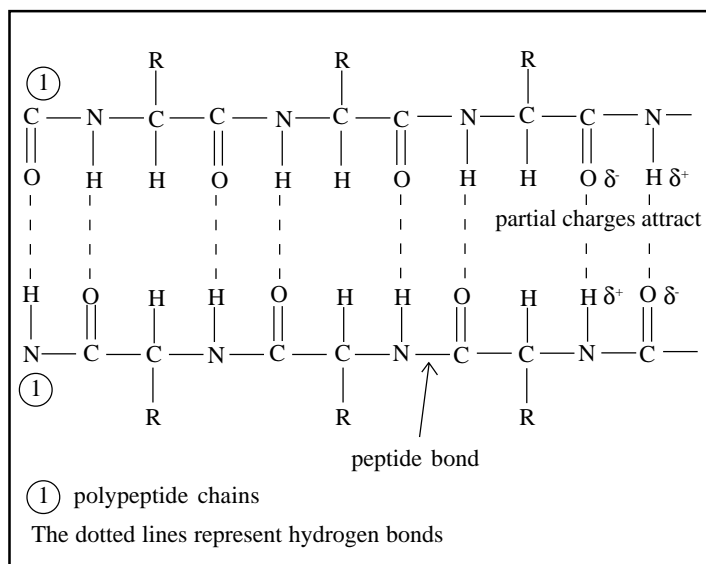

Sulphur bonds

Amino acids such as cysteine and methionine contain sulphhydryl (-SH) groups. The group has reducing properties since the H atom can be fairly easily removed. In proteins two nearby -SH groups may become oxidised (hydrogen loss) forming a cross-linking sulphur bond (-S-S-).

Sulphur bonds are stronger and more heat stable than hydrogen bonds and so proteins that contain many sulphur bonds tend to have good stability. The RNA splitting enzyme, ribonuclease, for example, does not denature (break down) unless temperatures are raised to around 95 °C whereas most proteins denature above 42 °C.

Phosphate bonds

These are found joining the adjacent nucleotides in DNA and RNA structure. They are formed by condensations of orthophosphoric acid (H₃PO₄) between the -OH groups on carbon 3 of one pentose sugar and carbon 5 of the pentose sugar of the next nucleotide. This is illustrated in Fig 10.

Fig 10. Orthophosphoric acid and a phosphate bond in RNA

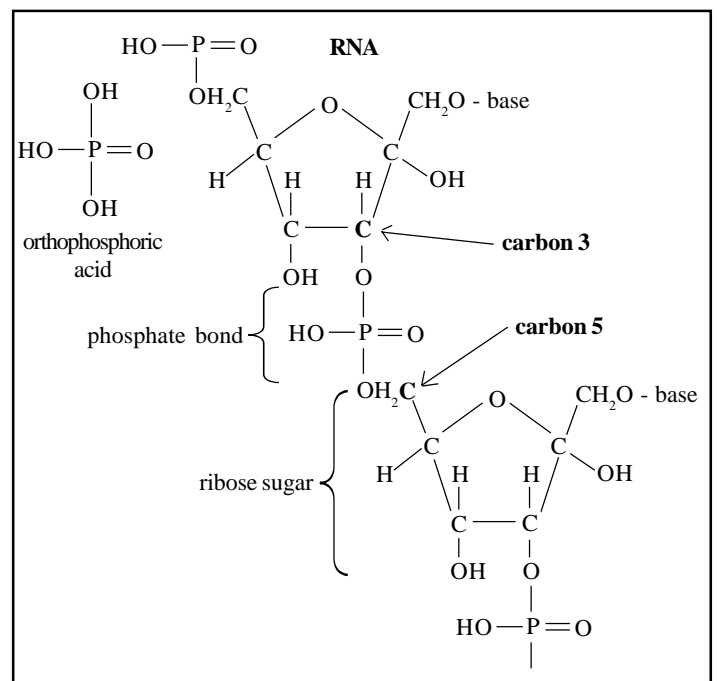

Exam Hint – Although examiners will not expect you to be able to write down structural formulae from memory, you will be expected to recognise molecular structures and to be able to manipulate molecules by joining them together with appropriate bonding.

Practice Questions

1. The table below refers to some biological molecules and to the type of chemical bonds they contain. Complete the table by filling in the empty boxes. Some boxes may have more than one answer.

Molecule	Type of bond
	only 1,4 alpha-glycosidic
between nucleotides in nucleic acids	
in amylopectin	
	ester bonds
	peptide bonds
between polypeptide chains	
in glycogen	

12

2. (a) Distinguish 'condensation' from 'hydrolysis'. 2

(b) The diagram below shows the general structure of two molecules of amino acid. Show how they would combine to form a dipeptide. 3

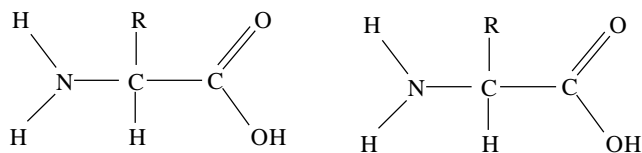

(c) (i) What is the name of the bond which joins together two adjacent amino acids? 1

(ii) Name three other types of bond involved in protein structure. 3

3. The carbohydrate below has been formed from two glucose molecules.

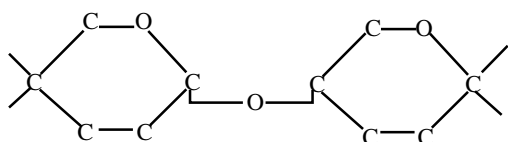

(a) What is this type of carbohydrate called? 1

(b) What is the name of the chemical bond which joins these two hexose units together? 2

(c) What is the chemical reaction in which one or more hexose units are joined together? 1

(d) (i) Draw a diagram to show how the two glucose molecules would have been bonded when forming part of a cellulose fibril. 1

(ii) Name the type of bond involved. 1

Answers

1.

Molecule	Type of bond
(alpha-)amylose;	only 1,4 alpha-glycosidic
between nucleotides in nucleic acids	phosphate bonds; hydrogen bonds;
in amylopectin	1,4 alpha-glycosidic; 1,6 branch glycosidic;
lipids/triglycerides;	ester bonds
polypeptides/proteins;	peptide bonds
between polypeptide chains	hydrogen bonds; sulphur bonds; ionic bonds;
in glycogen	1,4 alpha-glycosidic; 1,6 branch glycosidic;

12

2. (a) condensation is the joining of molecules by the removal of water; hydrolysis is the splitting of molecules by the addition of water; 2

(b) 2

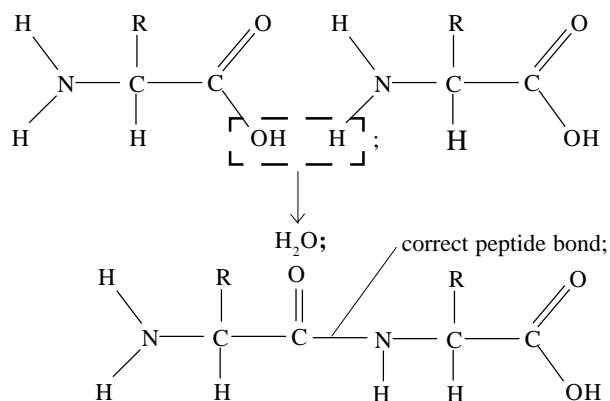

3

(c) (i) peptide bond; 1

(ii) hydrogen bond; sulphur bond; ionic bond; 2

3. (a) disaccharide; 1

(b) 1,4 alpha; glycosidic; 2

(c) condensation; (reject 'synthesis' which is the process) 1

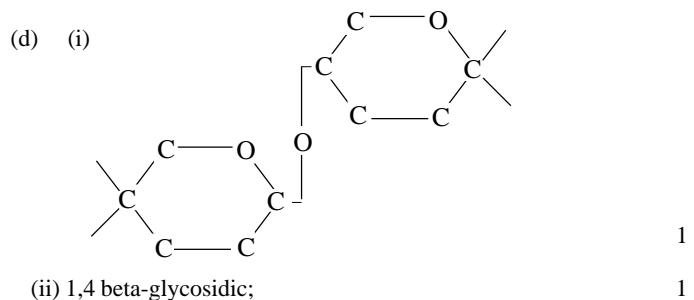

Acknowledgements;

This Factsheet was researched and written by Martin Griffin Curriculum Press, Unit 305B, The Big Peg, 120 Vyse Street, Birmingham. B18 6NF Bio Factsheets may be copied free of charge by teaching staff or students, provided that their school is a registered subscriber. No part of these Factsheets may be reproduced, stored in a retrieval system, or transmitted, in any other form or by any other means, without the prior permission of the publisher. ISSN 1351-5136